



# Pulse Transformers

For LAN interface

## ALT series

---

ALT3232M

ALT4532M

---

## REMINDERS FOR USING THESE PRODUCTS

Before using these products, be sure to request the delivery specifications.

### SAFETY REMINDERS

Please pay sufficient attention to the warnings for safe designing when using these products.

#### REMINDERS

- The storage period is less than 12 months. Be sure to follow the storage conditions (Temperature: 5 to 40°C, Humidity: 10 to 75% RH or less).  
If the storage period elapses, the soldering of the terminal electrodes may deteriorate.
- Do not use or store in locations where there are conditions such as gas corrosion (salt, acid, alkali, etc.).
- Before soldering, be sure to preheat components.  
The preheating temperature should be set so that the temperature difference between the solder temperature and chip temperature does not exceed 150°C.
- Soldering corrections after mounting should be within the range of the conditions determined in the specifications.  
If overheated, a short circuit, performance deterioration, or lifespan shortening may occur.
- When embedding a printed circuit board where a chip is mounted to a set, be sure that residual stress is not given to the chip due to the overall distortion of the printed circuit board and partial distortion such as at screw tightening portions.
- Self heating (temperature increase) occurs when the power is turned ON, so the tolerance should be sufficient for the set thermal design.
- Carefully lay out the coil for the circuit board design of the non-magnetic shield type.  
A malfunction may occur due to magnetic interference.
- Use a wrist band to discharge static electricity in your body through the grounding wire.
- Do not expose the products to magnets or magnetic fields.
- Do not use for a purpose outside of the contents regulated in the delivery specifications.
- The products listed on this catalog are intended for use in general electronic equipment (AV equipment, telecommunications equipment, home appliances, amusement equipment, computer equipment, personal equipment, office equipment, measurement equipment, industrial robots) under a normal operation and use condition.  
The products are not designed or warranted to meet the requirements of the applications listed below, whose performance and/or quality require a more stringent level of safety or reliability, or whose failure, malfunction or trouble could cause serious damage to society, person or property.  
If you intend to use the products in the applications listed below or if you have special requirements exceeding the range or conditions set forth in the each catalog, please contact us.

- (1) Aerospace/Aviation equipment
- (2) Transportation equipment (cars, electric trains, ships, etc.)
- (3) Medical equipment
- (4) Power-generation control equipment
- (5) Atomic energy-related equipment
- (6) Seabed equipment
- (7) Transportation control equipment

- (8) Public information-processing equipment
- (9) Military equipment
- (10) Electric heating apparatus, burning equipment
- (11) Disaster prevention/crime prevention equipment
- (12) Safety equipment
- (13) Other applications that are not considered general-purpose applications

When designing your equipment even for general-purpose applications, you are kindly requested to take into consideration securing protection circuit/device or providing backup circuits in your equipment.

# Pulse Transformers

For LAN interface

Product compatible with RoHS directive

Halogen-free

Compatible with lead-free solders

## Overview of the ALT Series

### FEATURES

- The ALT Series contains wound chip type pulse transformers developed for LANs.
- Compatible with 10BASE-T, 100BASE-TX, and 1000BASE-T.
- High-quality product that uses auto winding.
- Conforms to the RoHS Directive.

### APPLICATION

LAN interfaces of various devices including network devices, communication equipment, digital consumer electronics, etc.

### PART NUMBER CONSTRUCTION

ALT	3232	M	151	T	001		
Series name	LxWxH Dimensions (mm)		Product internal code	Inductance (μH min.) at 100kHz/DC bias=8mA		Packaging style	Internal code
	3232	3.2x3.2x2.9	M	151	150	T	Taping
	4532	4.5x3.2x2.2 4.5x3.2x2.9					

### OPERATING TEMPERATURE RANGE, PACKAGE QUANTITY, PRODUCT WEIGHT

Type	Temperature range		Package quantity (pieces/reel)	Individual weight (mg)
	Operating temperature* (°C)	Storage temperature** (°C)		
ALT3232M	-40 to +85	-40 to +85	2,000	120
ALT4532M-201	-40 to +85	-40 to +85	2,000	160
ALT4532M-171	-40 to +85	-40 to +85	2,000	110

\* Operating temperature range includes self-temperature rise.

\*\* The Storage temperature range is for after the circuit board is mounted.

○ RoHS Directive Compliant Product: See the following for more details.<https://product.tdk.com/info/en/environment/rohs/index.html>

○ Halogen-free: Indicates that Cl content is less than 900ppm, Br content is less than 900ppm, and that the total Cl and Br content is less than 1500ppm.

 Please be sure to request delivery specifications that provide further details on the features and specifications of the products for proper and safe use.  
Please note that the contents may change without any prior notice due to reasons such as upgrading.

# Overview of the ALT Series

## RECOMMENDED REFLOW PROFILE

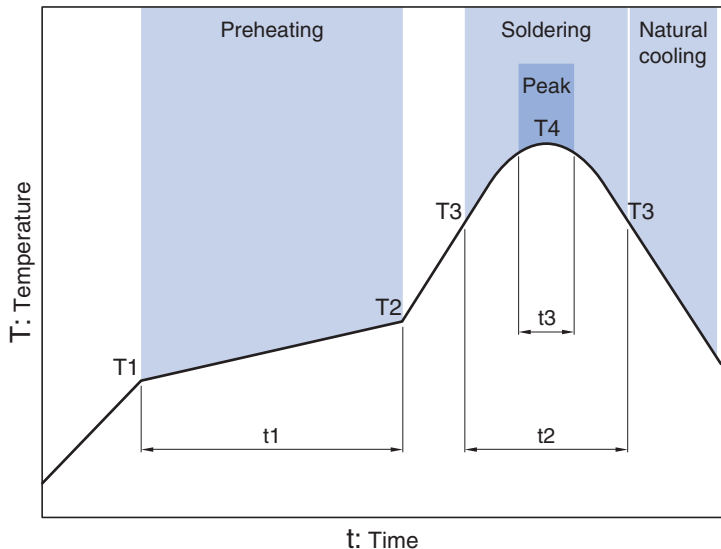

Preheating			Soldering		Peak	
Temp.	Temp.	Time	Temp.	Time	Temp.	Time
T1	T2	t1	T3	t2	T4	t3
150°C	180°C	60 to 120s	230°C	10 to 30s	245°C	5s max.

⚠ Please be sure to request delivery specifications that provide further details on the features and specifications of the products for proper and safe use. Please note that the contents may change without any prior notice due to reasons such as upgrading.

ALT series

# ALT3232M Type

## SHAPE & DIMENSIONS

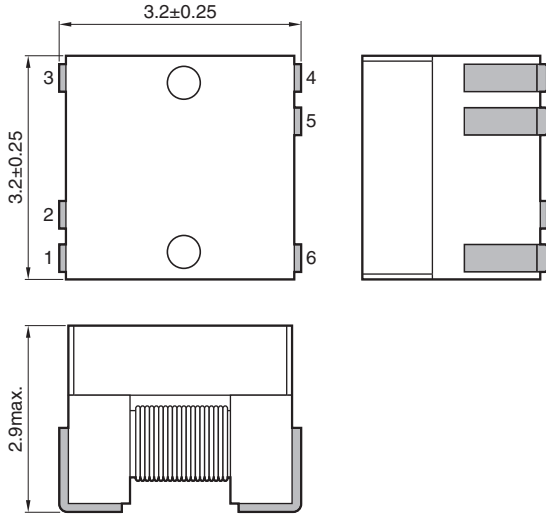

Dimensions in mm

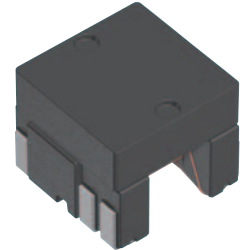

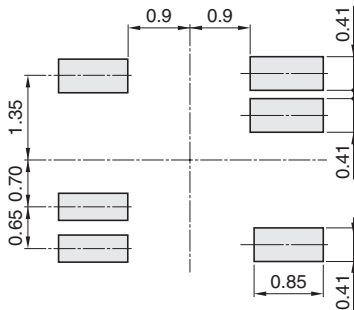

## RECOMMENDED LAND PATTERN

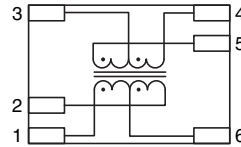

Dimensions in mm

## CIRCUIT DIAGRAM



 Please be sure to request delivery specifications that provide further details on the features and specifications of the products for proper and safe use. Please note that the contents may change without any prior notice due to reasons such as upgrading.

# ALT series **ALT3232M Type**

## ■ ELECTRICAL CHARACTERISTICS

### □ CHARACTERISTICS SPECIFICATION TABLE

Turns ratio ①⑥② : ⑤③④	Inductance [DC bias 8mA, 100kHz] ①-② ⑤-④ ( $\mu$ H)min.	Insertion loss [0.1 to 100MHz] ①②-⑤④ (dB)max.	Inter-winding stray capacitance [100kHz] (pF)max.	Part No.
1CT : 1CT	150	2.5	25	ALT3232M-151-T001

#### ○ Measurement equipment

Measurement item	Product No.	Manufacturer
Inductance	4284A	Keysight Technologies
Insertion loss	8753D	Keysight Technologies
Inter-winding stray capacitance	4284A	Keysight Technologies

\* Equivalent measurement equipment may be used.

### □ INSERTION LOSS VS. FREQUENCY CHARACTERISTICS

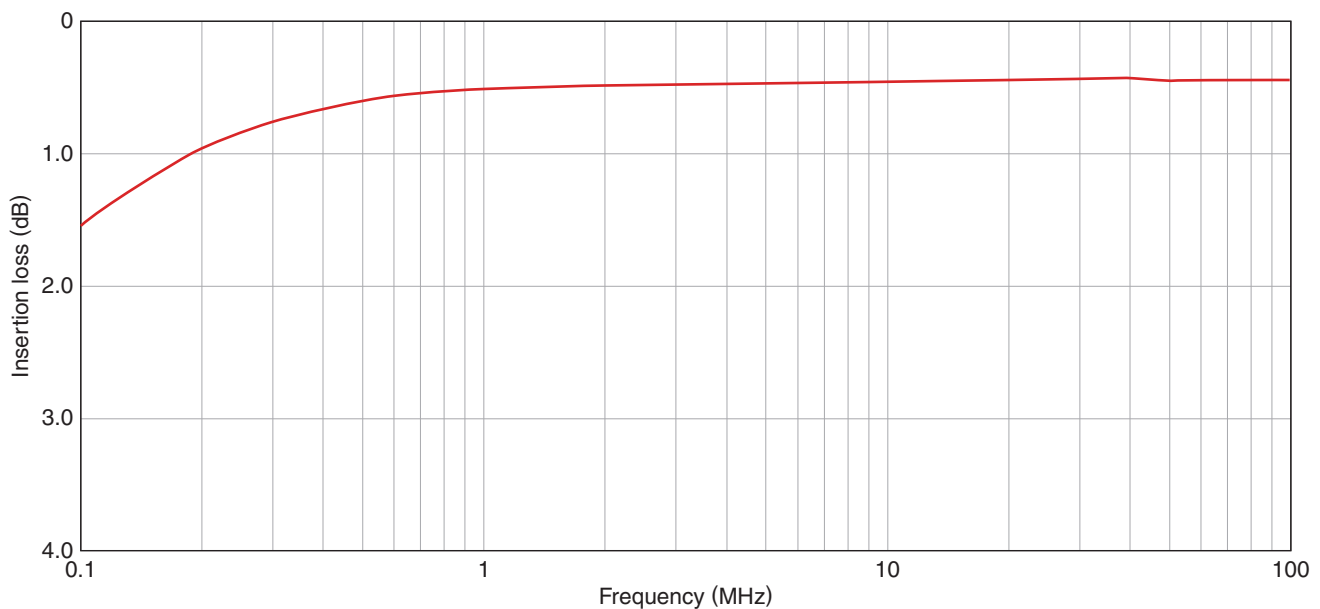

#### ○ Measurement equipment

Product No.	Manufacturer
8753D	Keysight Technologies

\* Equivalent measurement equipment may be used.

ALT series

# ALT4532M Type

## SHAPE & DIMENSIONS

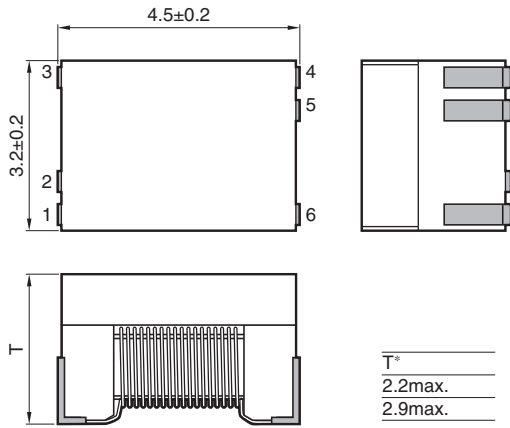

Dimensions in mm

\* Refer to 8 pages of CHARACTERISTICS SPECIFICATION TABLE.

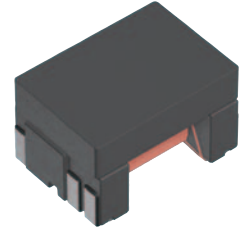

## RECOMMENDED LAND PATTERN

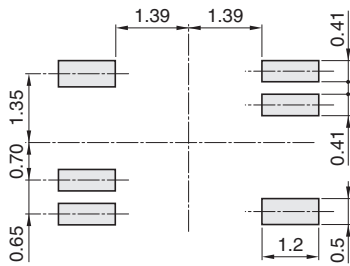

Dimensions in mm

## CIRCUIT DIAGRAM

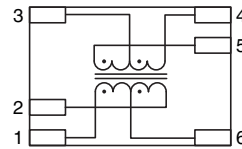

ALT series **ALT4532M Type**

## ■ ELECTRICAL CHARACTERISTICS

## □ CHARACTERISTICS SPECIFICATION TABLE

Turns ratio ①⑥② : ⑤③④	Inductance [DC bias 8mA, 100kHz] ①-② ⑤-④ ( $\mu\text{H}$ )min.	Insertion loss [0.1 to 100MHz] ①②-⑤④ (dB)max.	Inter-winding stray capacitance [100kHz] (pF)max.	Thickness T (mm)max.	Part No.
1CT : 1CT	170	2.5	35	2.2	ALT4532M-171-T001
1CT : 1CT	200	1.5	35	2.9	ALT4532M-201-T001

○ Measurement equipment

Measurement item	Product No.	Manufacturer
Inductance	4284A	Keysight Technologies
Insertion loss	8753D	Keysight Technologies
Inter-winding stray capacitance	4284A	Keysight Technologies

\* Equivalent measurement equipment may be used.

## □ INSERTION LOSS VS. FREQUENCY CHARACTERISTICS

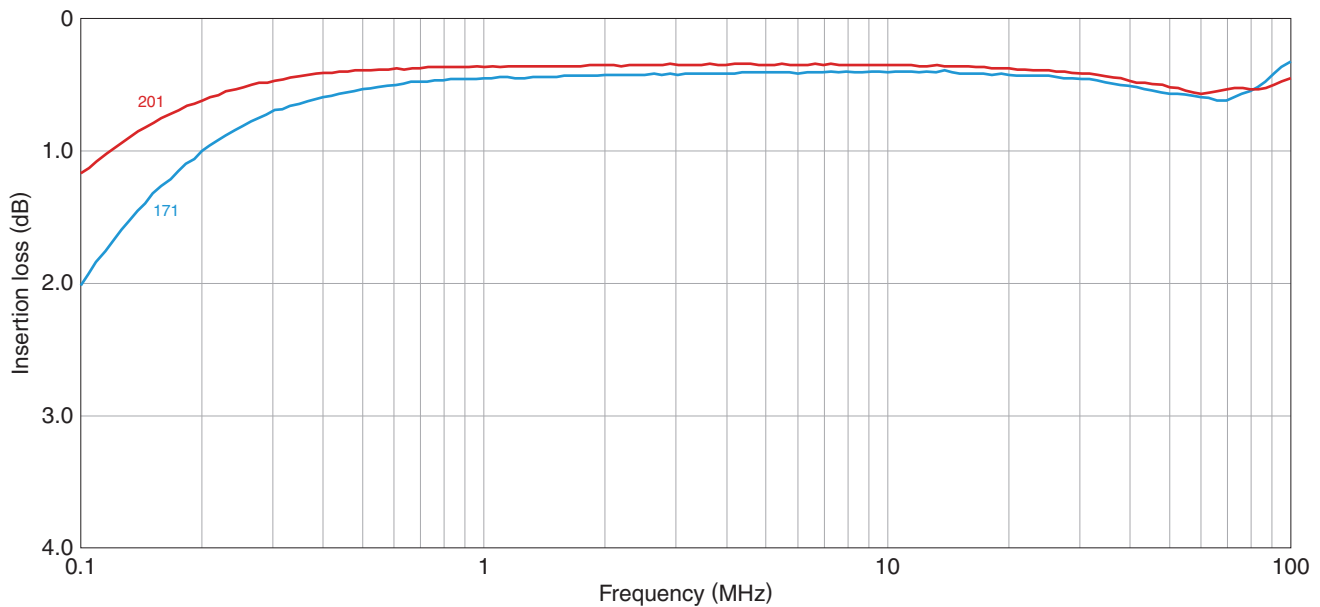

○ Measurement equipment

Product No.	Manufacturer
8753D	Keysight Technologies

\* Equivalent measurement equipment may be used.



ALT series

# Packaging style

## REEL DIMENSIONS

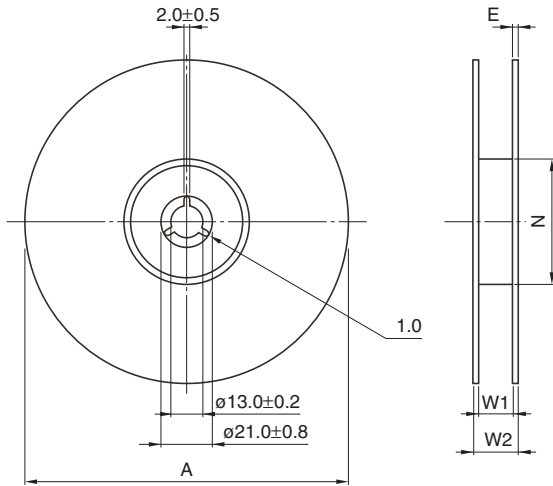

Dimensions in mm

Type	A	W1	W2	N	E
ALT3232M	$\phi 330 \pm 2$	$13.5 \pm 0.5$	$17.5 \pm 1$	$100 \pm 1$	2 typ.
ALT4532M	$\phi 330 \pm 2$	$13.5 \pm 0.5$	$17.5 \pm 1$	$100 \pm 1$	2 typ.

## TAPE DIMENSIONS

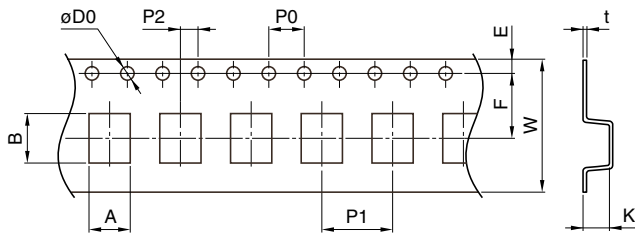

Dimensions in mm

Type	A	B	$\phi D0$	E	F	P0	P1	P2	W	K	t
ALT3232M	$3.55 \pm 0.1$	$3.55 \pm 0.1$	$1.5 \pm 0.1/0$	$1.75 \pm 0.1$	$5.5 \pm 0.1$	$4.0 \pm 0.1$	$8.0 \pm 0.1$	$2.0 \pm 0.1$	$12.0 \pm 0.2$	$3.0 \pm 0.1$	$0.3 \pm 0.05$
ALT4532M	$3.6 \pm 0.1$	$4.9 \pm 0.1$	$1.5 \pm 0.1/0$	$1.75 \pm 0.1$	$5.5 \pm 0.05$	$4.0 \pm 0.1$	$8.0 \pm 0.1$	$2.0 \pm 0.1$	$12.0 \pm 0.2$	3.25max.	$0.3 \pm 0.05$

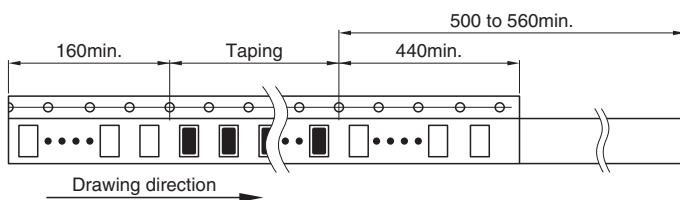

Dimensions in mm

⚠ Please be sure to request delivery specifications that provide further details on the features and specifications of the products for proper and safe use.  
Please note that the contents may change without any prior notice due to reasons such as upgrading.