

DETAILS

Product Number	F14616_ANGELETTE-S-B
Family	Angelette
Type	Reflector
Color	metal
Diameter	110 mm
Height	57,3 mm
Style	round
Optic Material	PC
Holder Material	
Fastening	
Status	production ready
ROHS Compliant	Yes
Date Updated	12/04/2017



OPTICAL PROPERTIES

LED	Viewing	Light	Effi-		Connector
	Angle	Beam	ciency	cd/lm	
V15 Gen6	13 deg	Asymmetric	91 %	7.400	BJB: 47.319.2224
V18 Gen6	15 deg	Asymmetric	91 %	6.000	BJB: 47.319.2274
V22 Gen6	18 deg	Asymmetric	89 %	4.300	A.A.G. STUCCHI: 8102/G2
V18 Gen7	15 deg	Asymmetric	91 %	5.500	BJB: 47.319.2350
CLL03x/CLU03x	sim: 12	Asymmetric	sim: 90 %	sim: 10.400	BJB: 47.319.2021
CLL04x/CLU04x	sim: 17	Asymmetric	sim: 89 %	sim: 4.900	BJB: 47.319.2030
CXA/B 1816 & CXA/B 1820 & CXA 1850	10 deg	Asymmetric	91 %	10.700	A.A.G. STUCCHI: 8403/G2
CXA/B 25xx	14 deg	Asymmetric	90 %	5.900	A.A.G. STUCCHI: 8401/G2
LUXEON CoB 1208	12 deg	Asymmetric	91 %	7.800	A.A.G. STUCCHI: 8301/G2
COB D Series LES 22 mm	sim: 18	Asymmetric	sim: 88 %	sim: 4.470	BJB: 47.319.2030
COB D Series LES 14.5 mm	12 deg	Asymmetric	91 %	7.720	A.A.G. STUCCHI: 8101/G2
COB D Series LES 14.5 mm	12 deg	Asymmetric	91 %	7.720	BJB: 47.319.2021
SLE G6 LES19 H	sim: 13	Asymmetric	sim: 90 %	sim: 7.140	-
SLE G6 LES23 H	sim: 16	Asymmetric	sim: 89 %	sim: 5.120	-
SLE G6 LES17 H	sim: 12	Asymmetric	sim: 89 %	sim: 8.400	-
SLE G6 LES15 H D50	sim: 13	Asymmetric	sim: 90 %	sim: 7.290	-

NOTE:
 Customer may add additional light modifying parts to Angelette family(excluding the plain versions):
 Minimum height of additional part is 1.5mm and maximum is 2.2mm. Diameter is 105.9mm±0.3

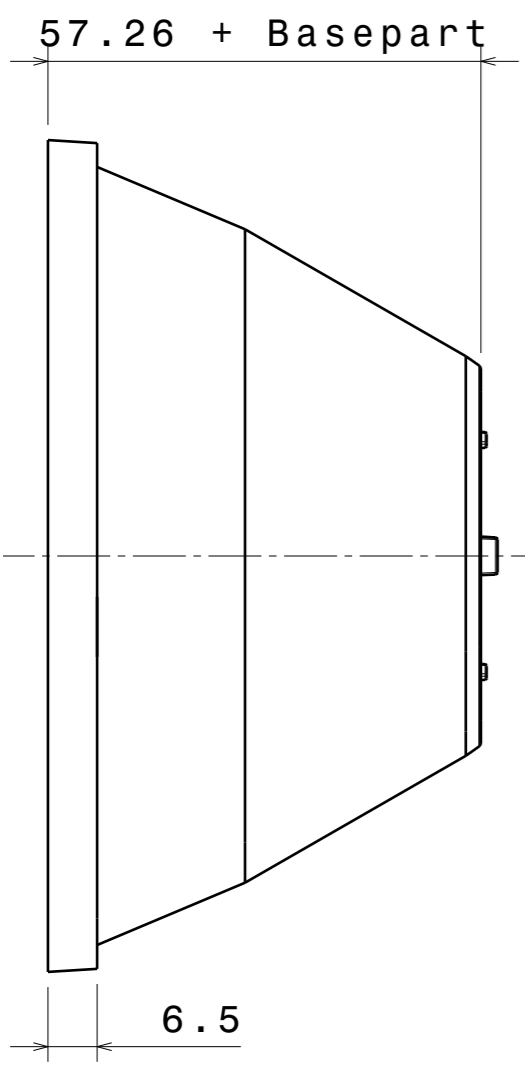

Front view

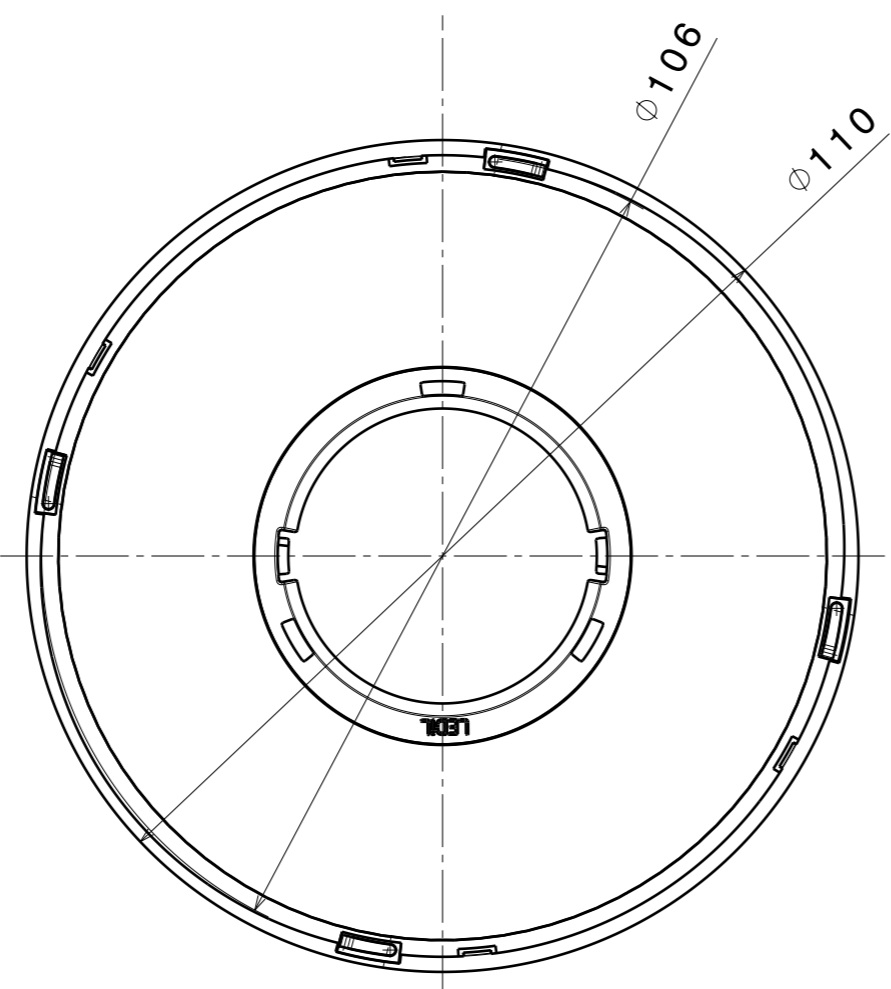

Top view

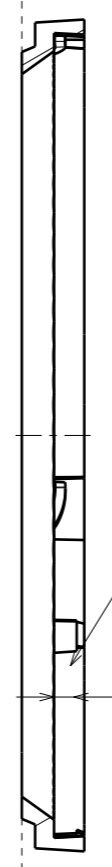

Additional part

Section view A-A

ANGELETTE-S-B

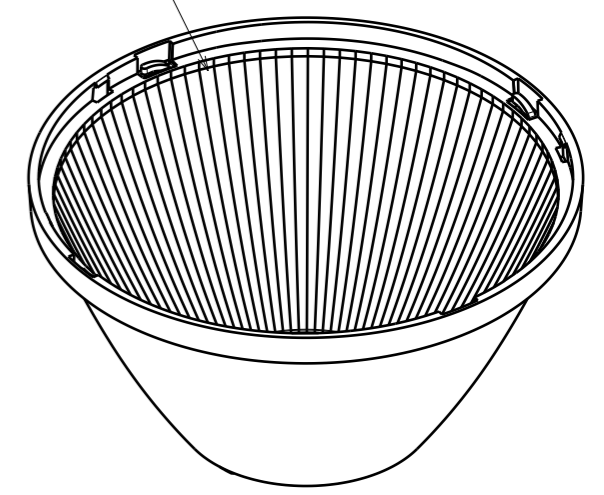

ANGELETTE-S_B-PLAIN

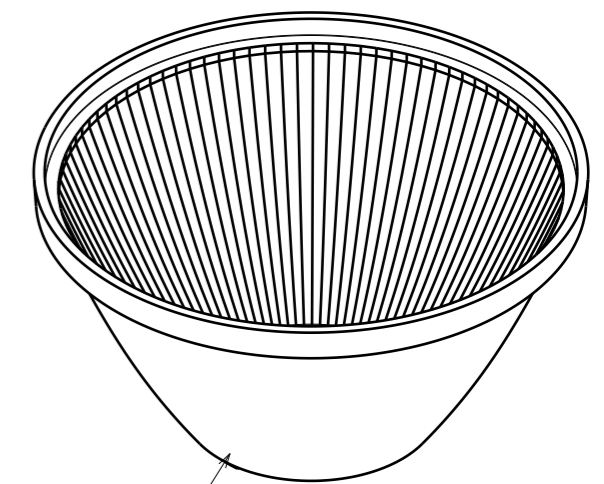

Tolerances if not otherwise shown
 According to DIN ISO 2768-1
 Linear measures:
 up to 30mm class M, otherwise class C
 According to DIN ISO 2768-2
 Form and position: class L

LEDiL Ledil Oy
 Salorankatu 10
 FIN 24240 SALO
 Finland

THIRD ANGLE PROJECTION:

DRAWING TITLE
Datasheet_ANGELETTE-S-B

This drawing is the property
 of LEDiL Oy. It may not be
 reproduced, copied or
 communicated without a written
 agreement with LEDiL Oy.

SIZE **A3** PART NUMBER **ANGELETTE-S-B**
ANGELETTE-S-B-PLAIN

SCALE **1:1** WEIGHT SHEET **1/1**

Luminaire: Ledil F14616_ANGELETTE-S-B_(V15+BJB)

Lamps: 1 x Bridgelux_V15_+47.319.2224_1096.43lm@250mA_P=8.2647W_I=0.25A

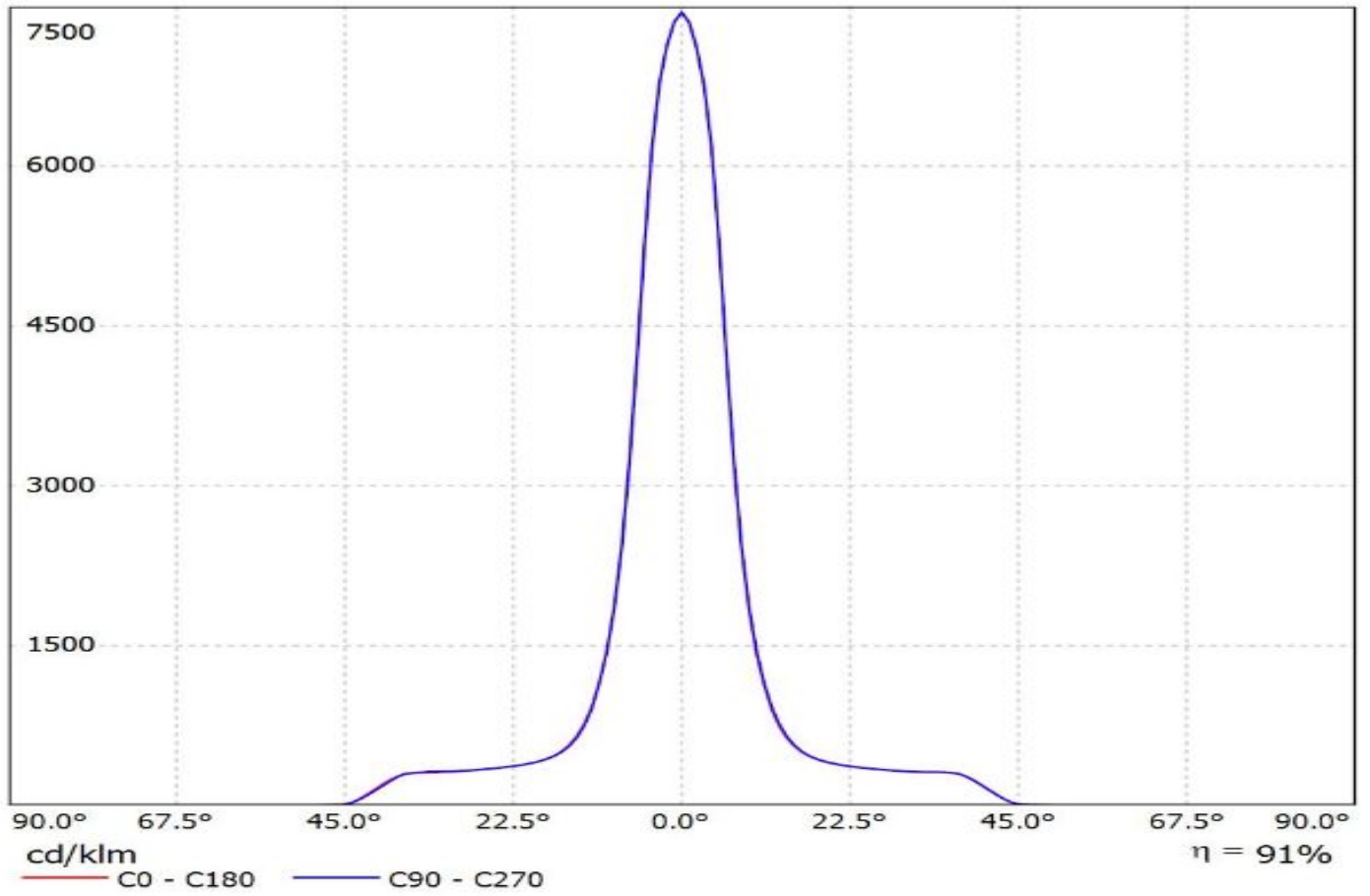

Luminaire: Ledil F14616_ANGELETTE-S-B_(V18+BJB)
Lamps: 1 x Bridgelux_V18_(BXRC-30E4000-F-23)
_+47.319.2274_1094.62lm@250mA_CCT=3000K_P=6.875W_I=0.25A

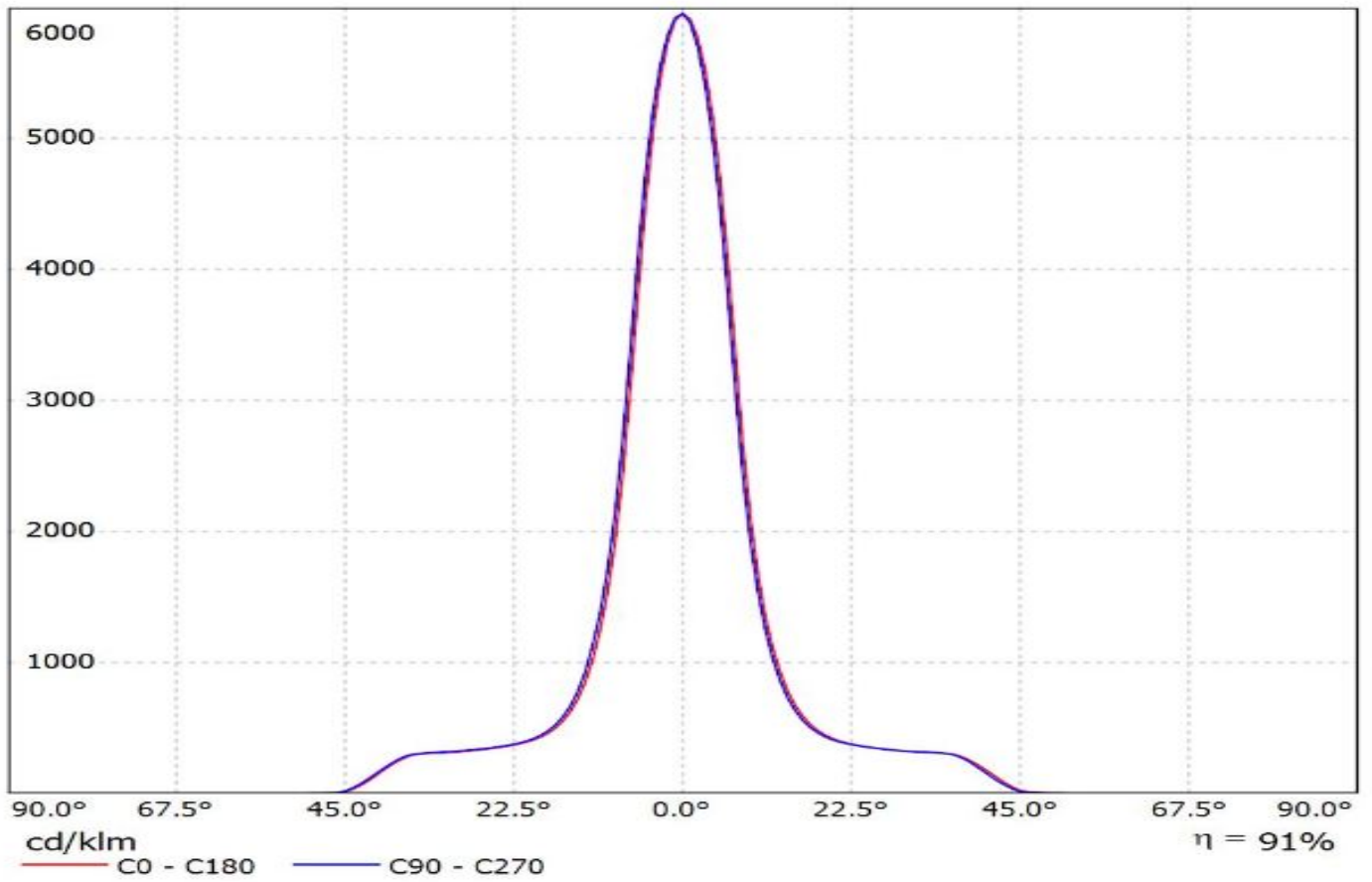

Luminaire: Ledil F14616_ANGELETTE-S-B_(V22+STUCCHI)
Lamps: 1 x Bridgelux_V22_(BXRE30E6500H-Y2)
_+8102/G2_1226.78lm@250mA_CCT=3000K_P=8.111W_I=0.25A

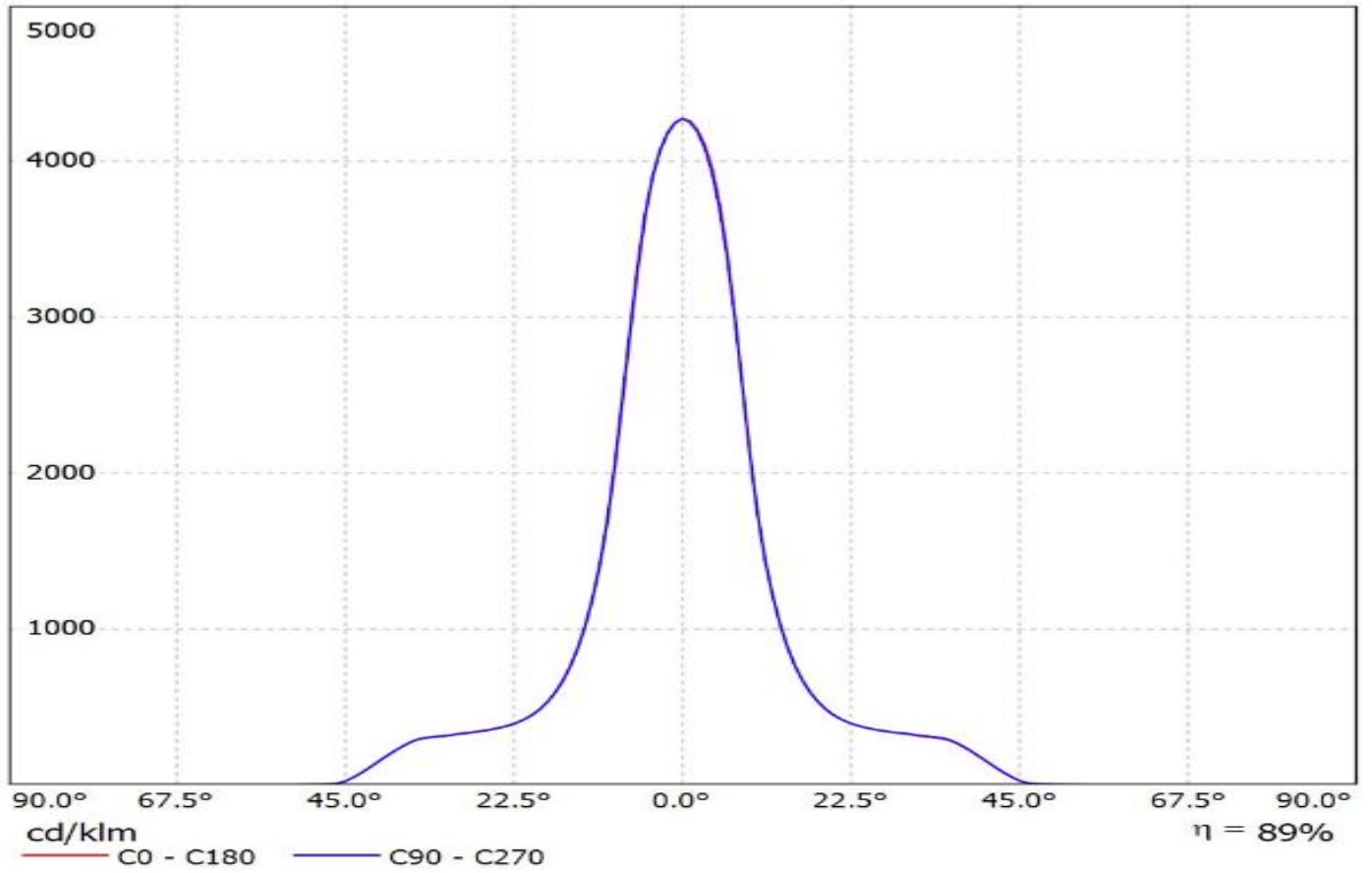

Luminaire: LEDiL Oy F14616_ANGELETTE-S-B_(V18_Gen7)+BJB

Lamps: 1 x Bridgelux_V18_Gen7_(BXRE-30E4000-B)+BJB_47.319.2350_1384.73lm@250mA_P=8.09577W_I=0.25A

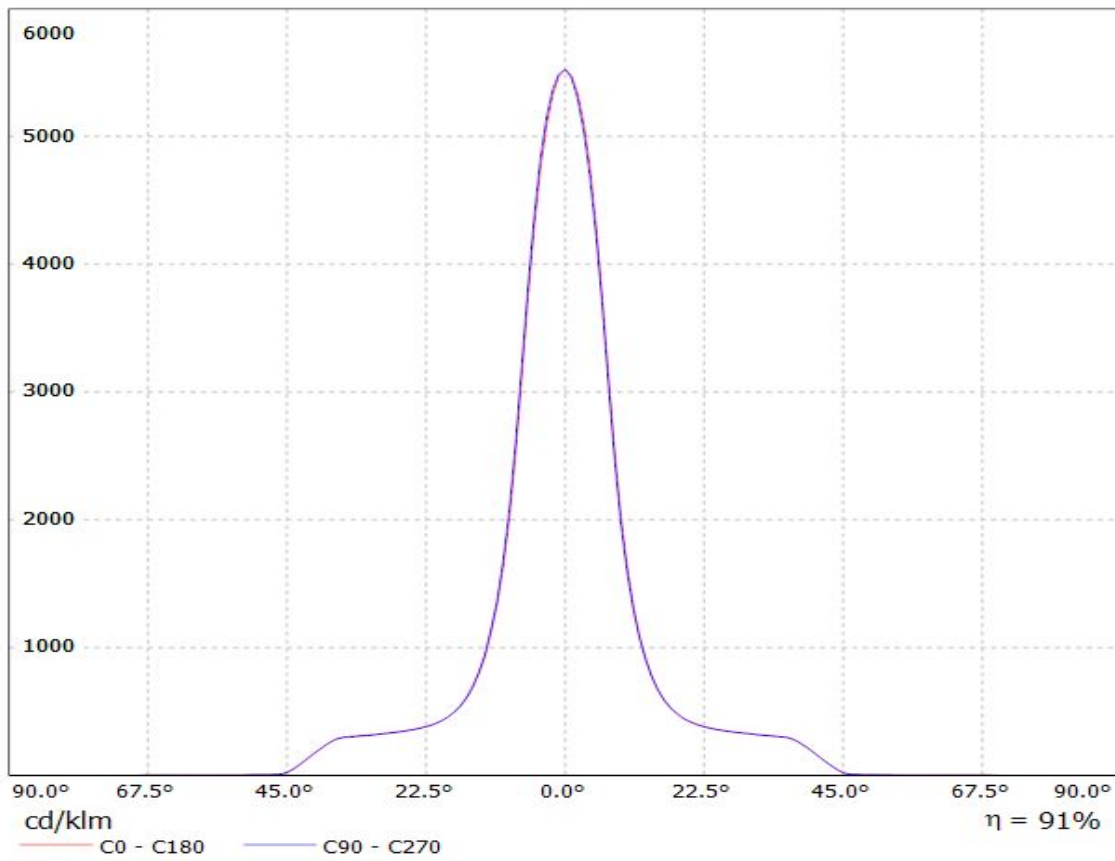

Luminaire: Ledil Oy F14616_ANGELETTE-S-B_(CLU038)_(47_319_2021)_SIMULATED
Lamps: 1 x Citizen CLU038-1210C4-303M2K1 + BJB 47.319.2021 connector

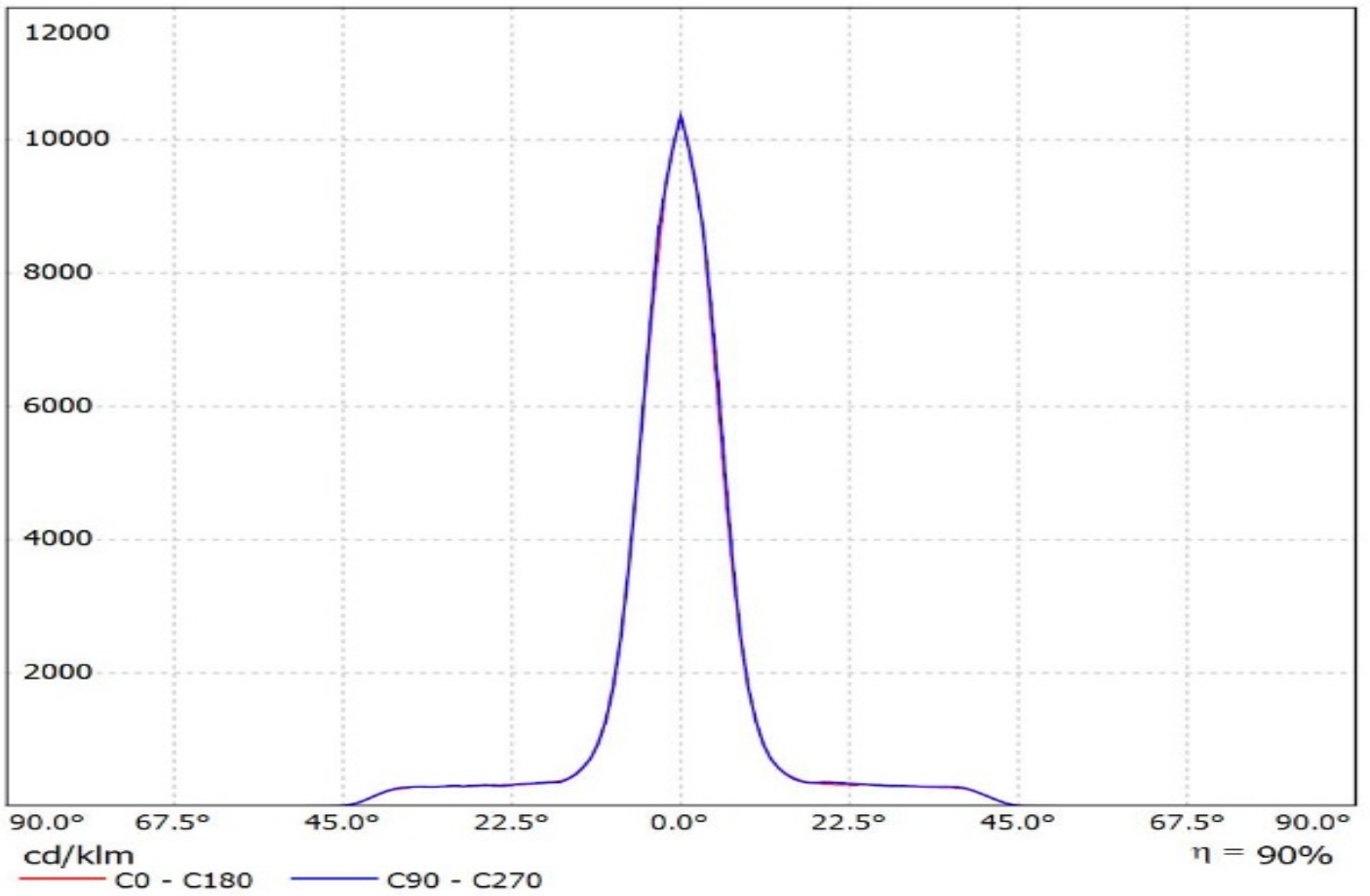

Luminaire: Ledil Oy F14616_ANGELETTE-S-B_(CLU048)_(47_319_2030)_SIMULATED
Lamps: 1 x Citizen CLU048-1818C4-303M2K1 + BJB 47.319.2030 connector

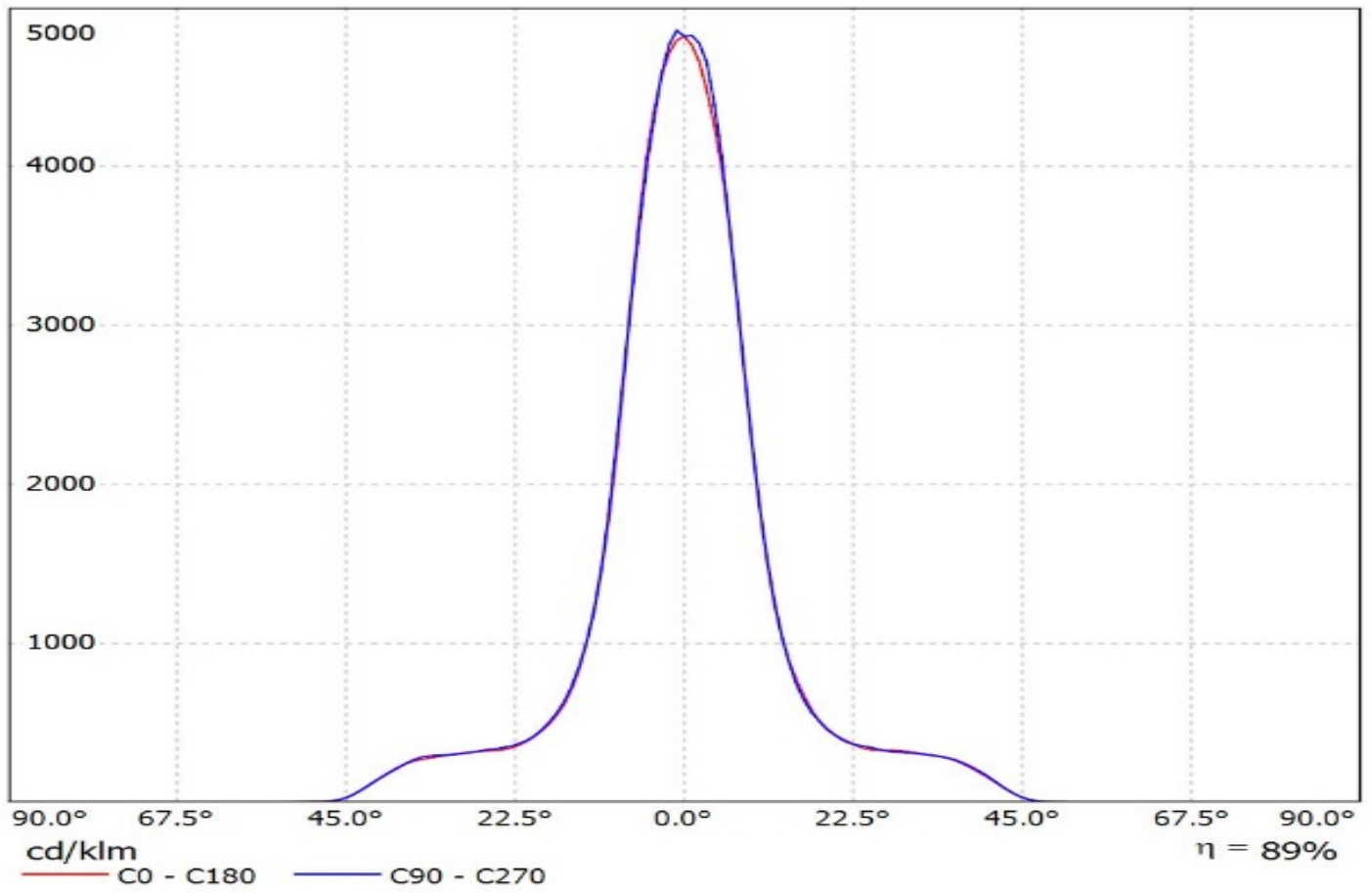

Luminaire: LEDiL Oy F14616_ANGELETTE-S-B_(CXA1850)_STUCCHI_8403G2
Lamps: 1 x Cree_CXA1850_(CXA1850-30F-T4-N0Y-00001)+STUCCHI_8403G2_787.743lm@250mA_P=8.2479W_I=0.250

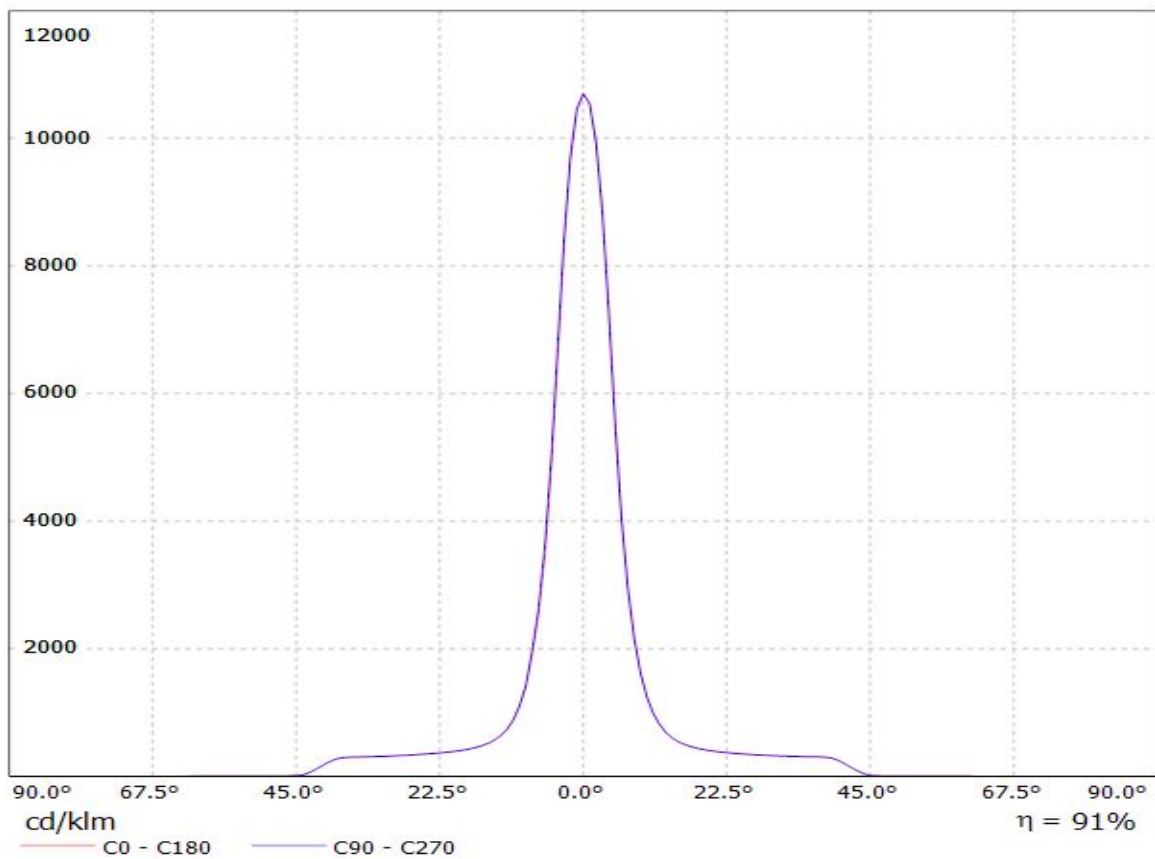

Luminaire: LEDiL Oy F14616_ANGELETTE-S-B_(CXA2520)+STUCCHI_8401/G2
Lamps: 1 x Cree_CXA2520_(2520-7A-N4-N0U)_888.176lm@250mA_P=8.65835W_I=0.250A

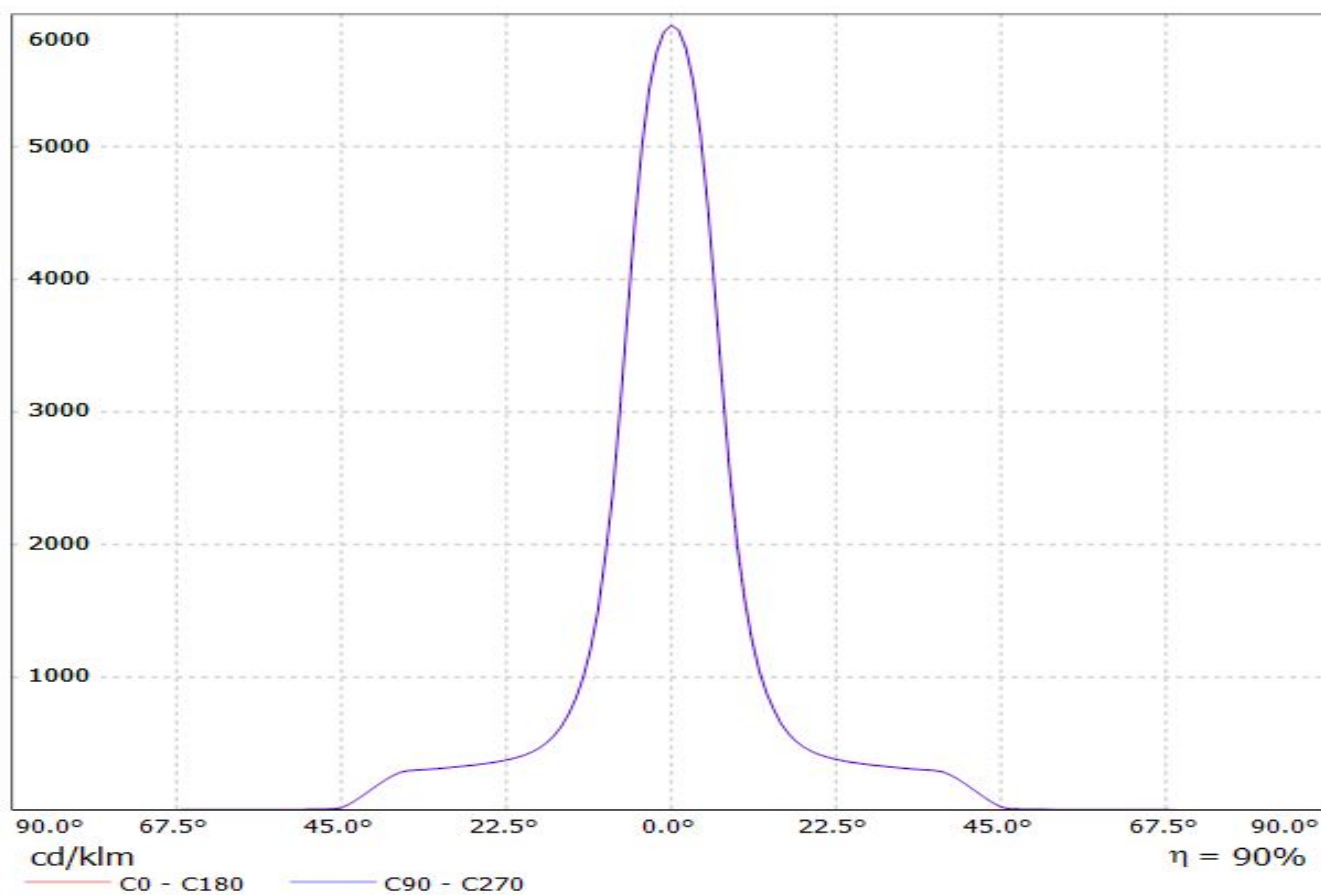

Luminaire: Ledil F14616_ANGELETTE-S-B_(CoB1208+STUCCHI)

Lamps: 1 x Luxeon_CoB1208_(L2C2-4080)_+_8301/G2_1410.19lm@250mA_P=8.1722W_I=0.25A

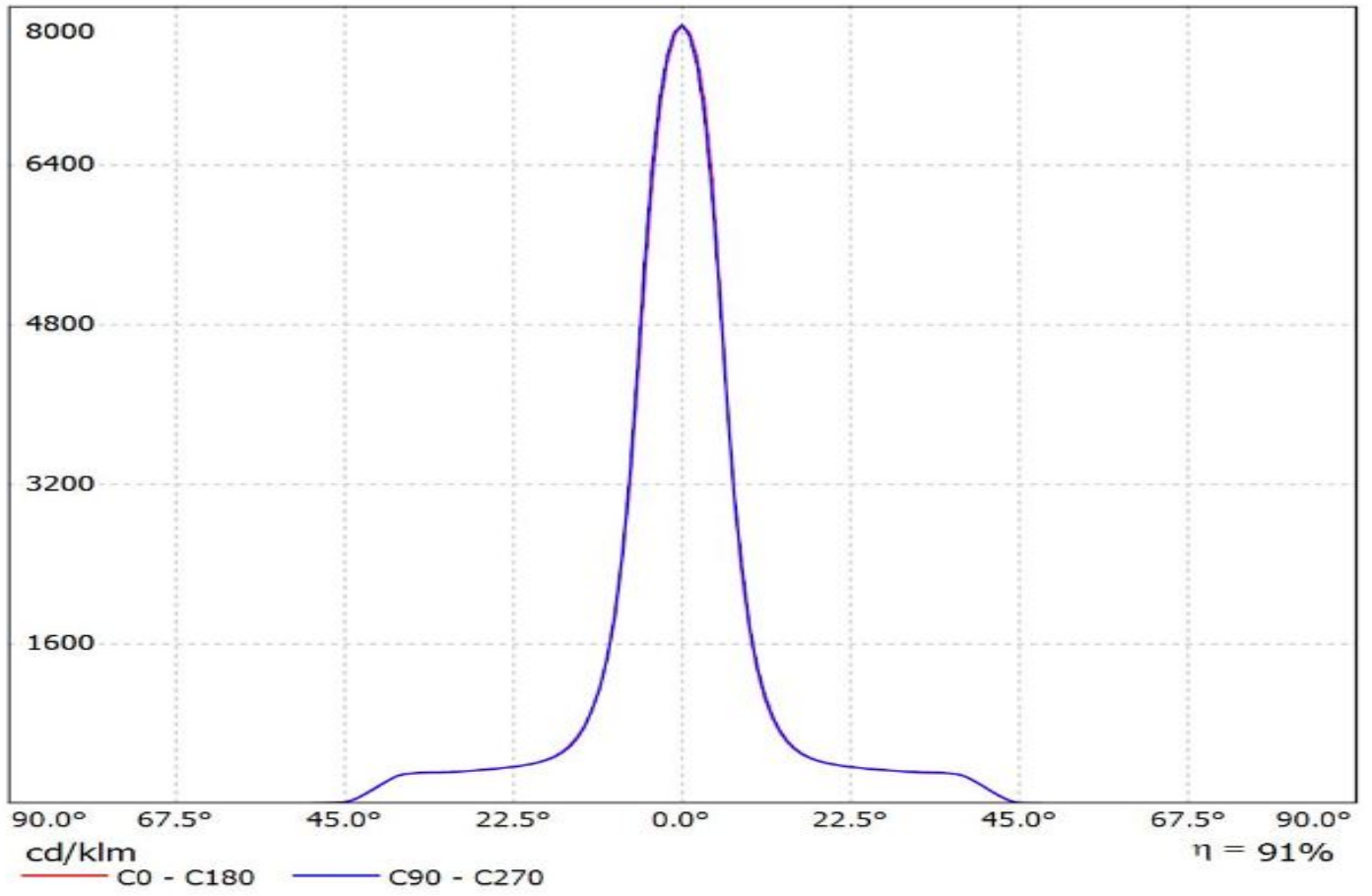

Luminaire: Ledil Oy F14616_ANGELETTE-S-B+_BJB_47.319.2030_SAMSUNG_COB_D_LC040D_SIMULATED
Lamps: 1 x SAMSUNG LC040D

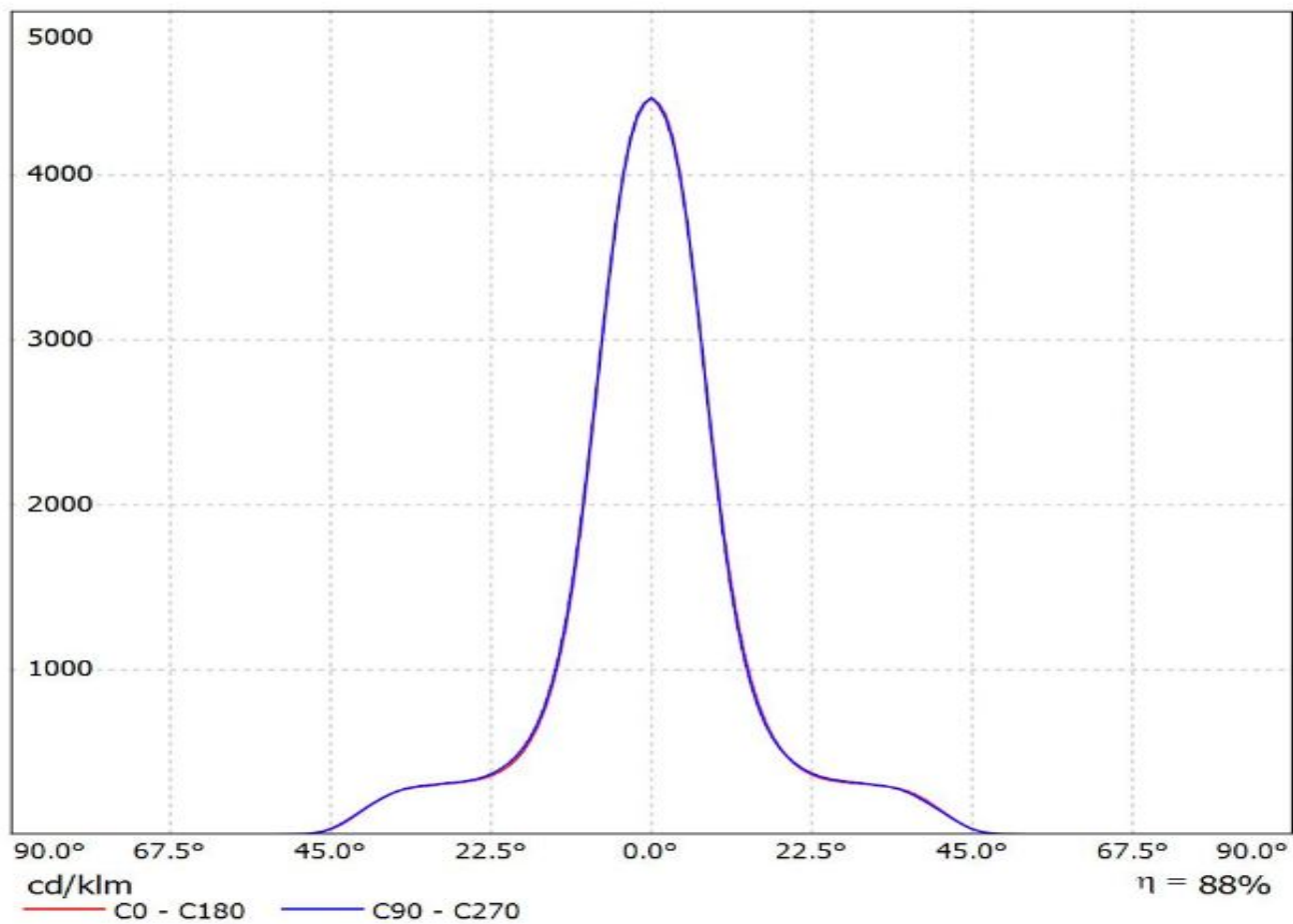

Luminaire: LEDiL Oy F14616_ANGELETTE-S-B (COB_D_14,5mm)

Lamps: 1 x Samsung_COB_D_Series-LES-14,5_LC026D_1296.34lm@250mA_CCT=3000K_P=8.1225W_I=0.250A

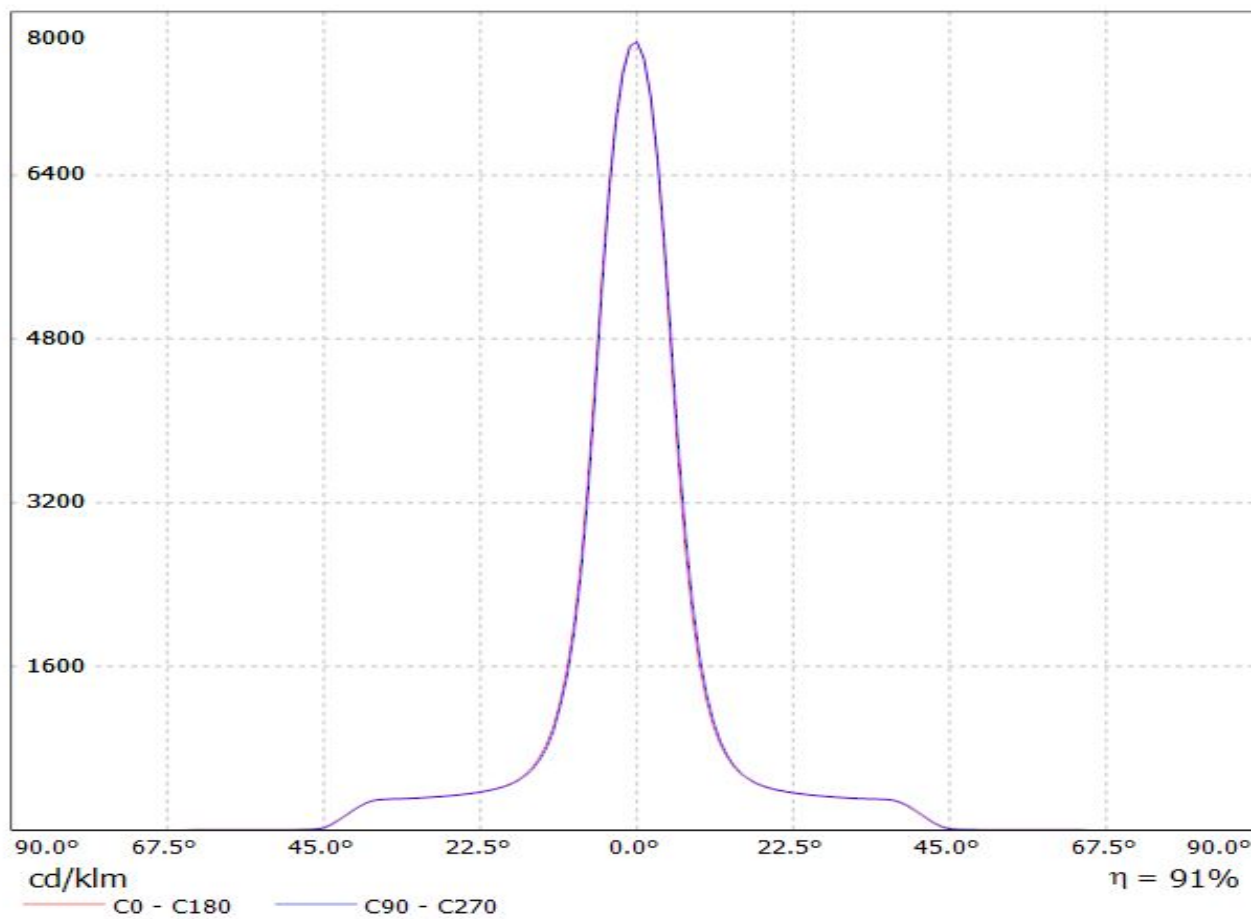

Luminaire: LEDiL Oy F14616_ANGELETTE-S-B (COB_D_14,5mm)

Lamps: 1 x Samsung_COB_D_Series-LES-14,5_LC026D_1296.34lm@250mA_CCT=3000K_P=8.1225W_I=0.250A

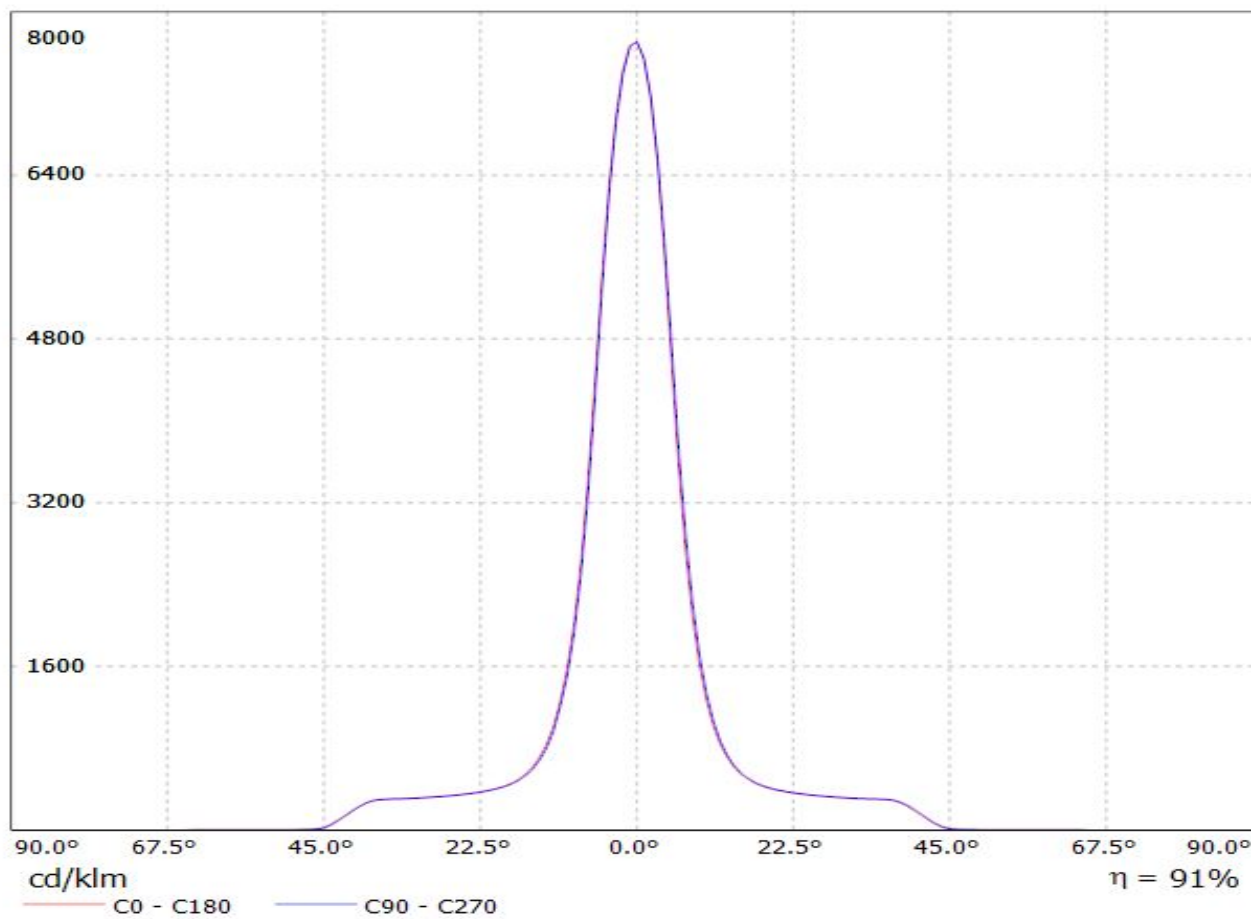

Luminaire: Ledil Oy F14616_ANGELETTE-S-B_TRIDONIC_SLE_G6_LES19_H_SIMULATED
Lamps: 1 x TRIDONIC SLE G6 LES19 H

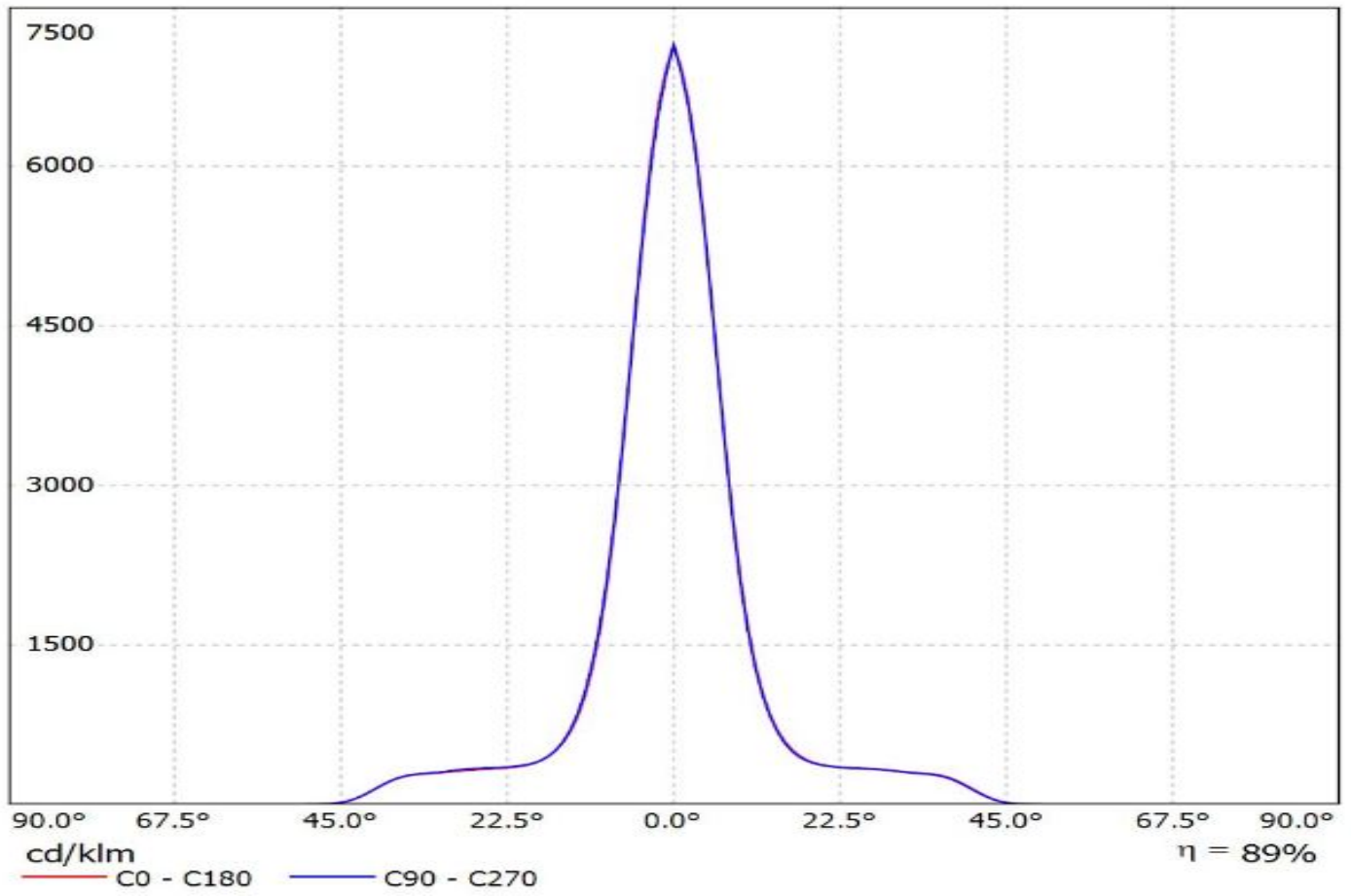

Luminaire: Ledil Oy F14616_ANGELETTE-S-B_TRIDONIC_SLE_G6_LES23_H_SIMULATED
Lamps: 1 x TRIDONIC SLE G6 LES23 H

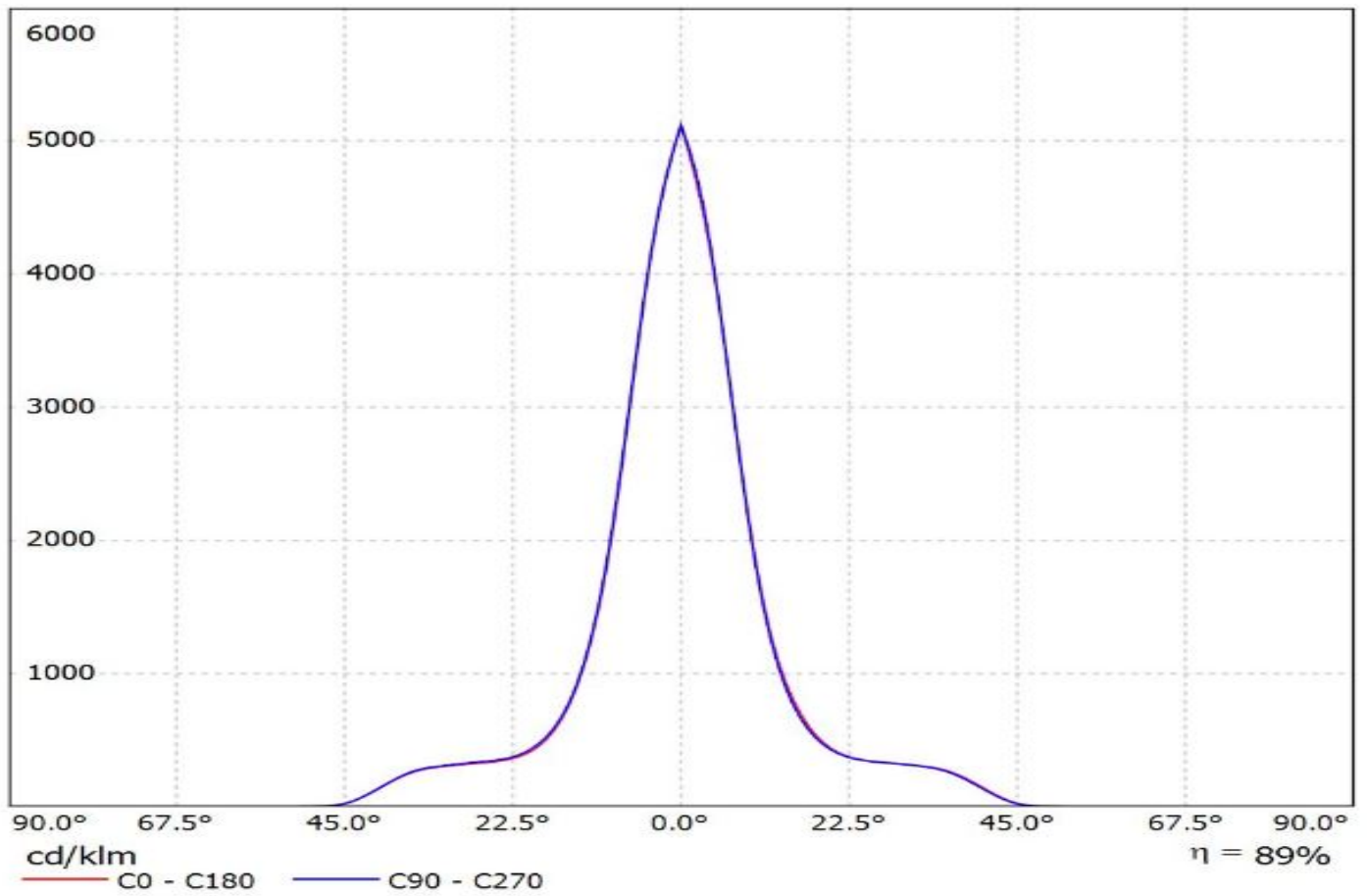

Luminaire: Ledil Oy F14616_ANGELETTE-S-B_(SLE_G6_LES17_H)_SIMULATED
Lamps: 1 x Tridonic SLE G6 LES17 H

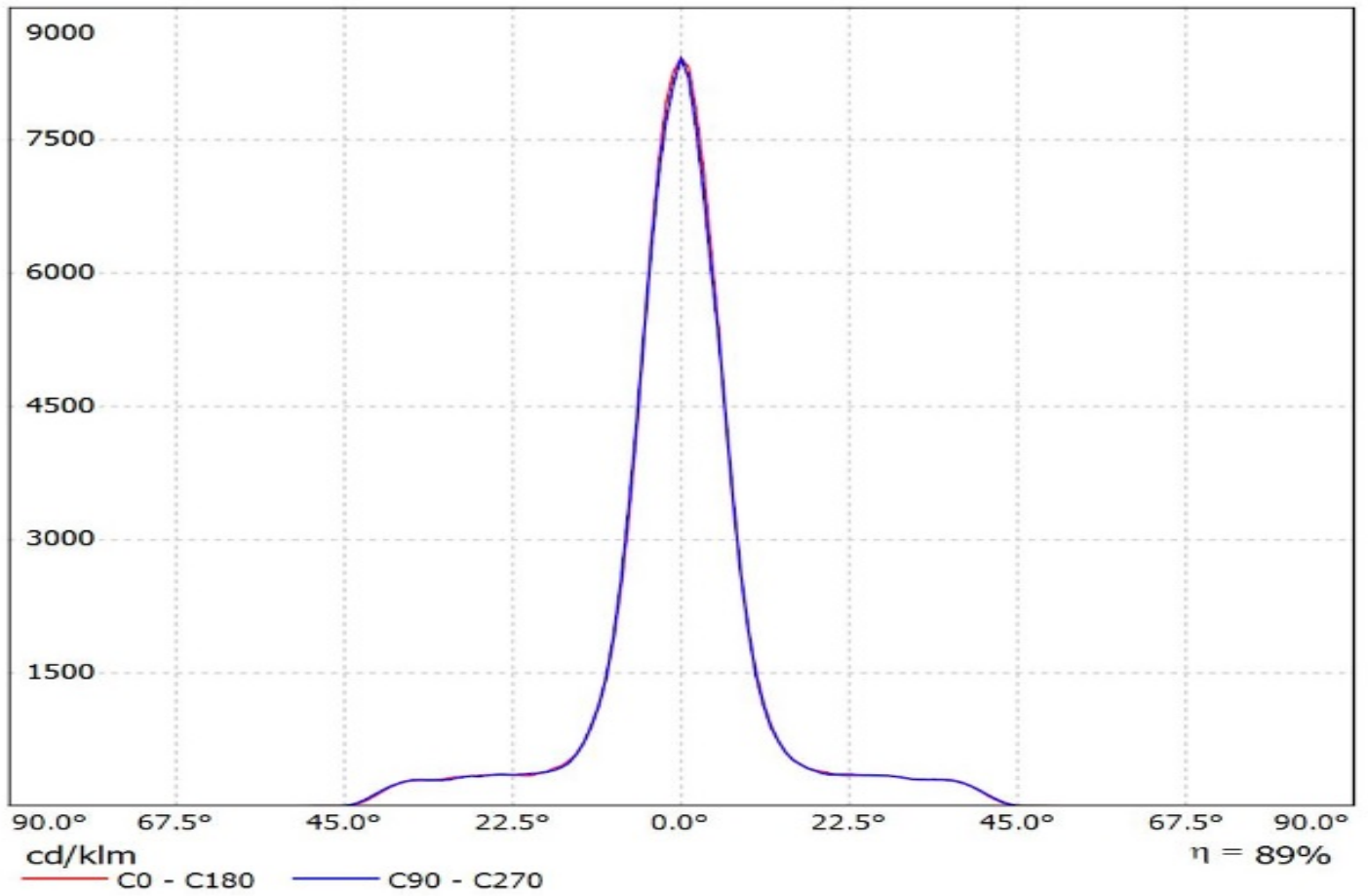

Luminaire: Ledil F14616_ANGELETTE-S-B_(V15+BJB)

Lamps: 1 x Bridgelux_V15_+47.319.2224_1096.43lm@250mA_P=8.2647W_I=0.25A

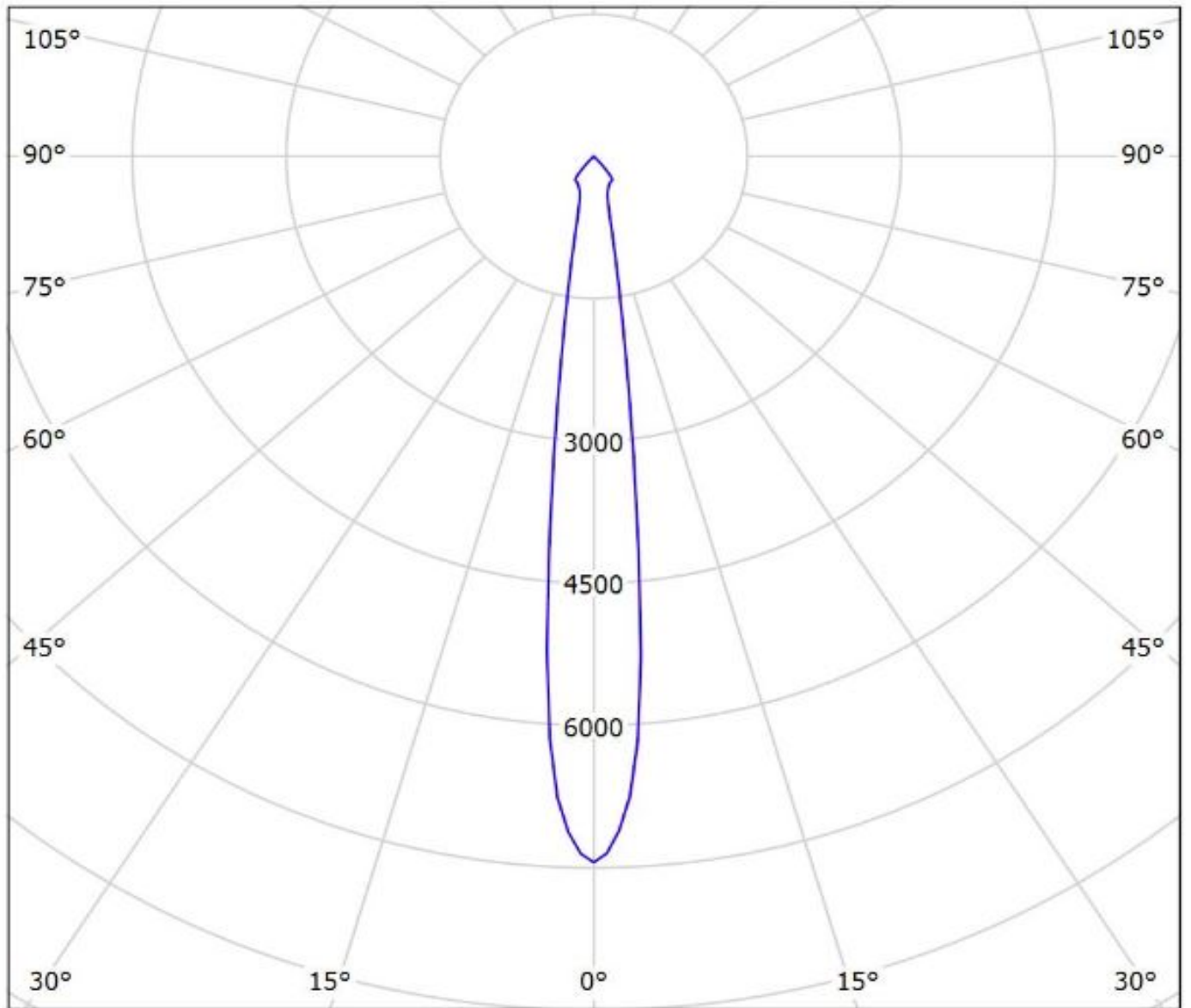

cd/klm

— C0 - C180

— C90 - C270

$\eta = 91\%$

Luminaire: Ledil F14616_ANGELETTE-S-B_(V18+BJB)
Lamps: 1 x Bridgelux_V18_(BXRC-30E4000-F-23)
_+47.319.2274_1094.62lm@250mA_CCT=3000K_P=6.875W_I=0.25A

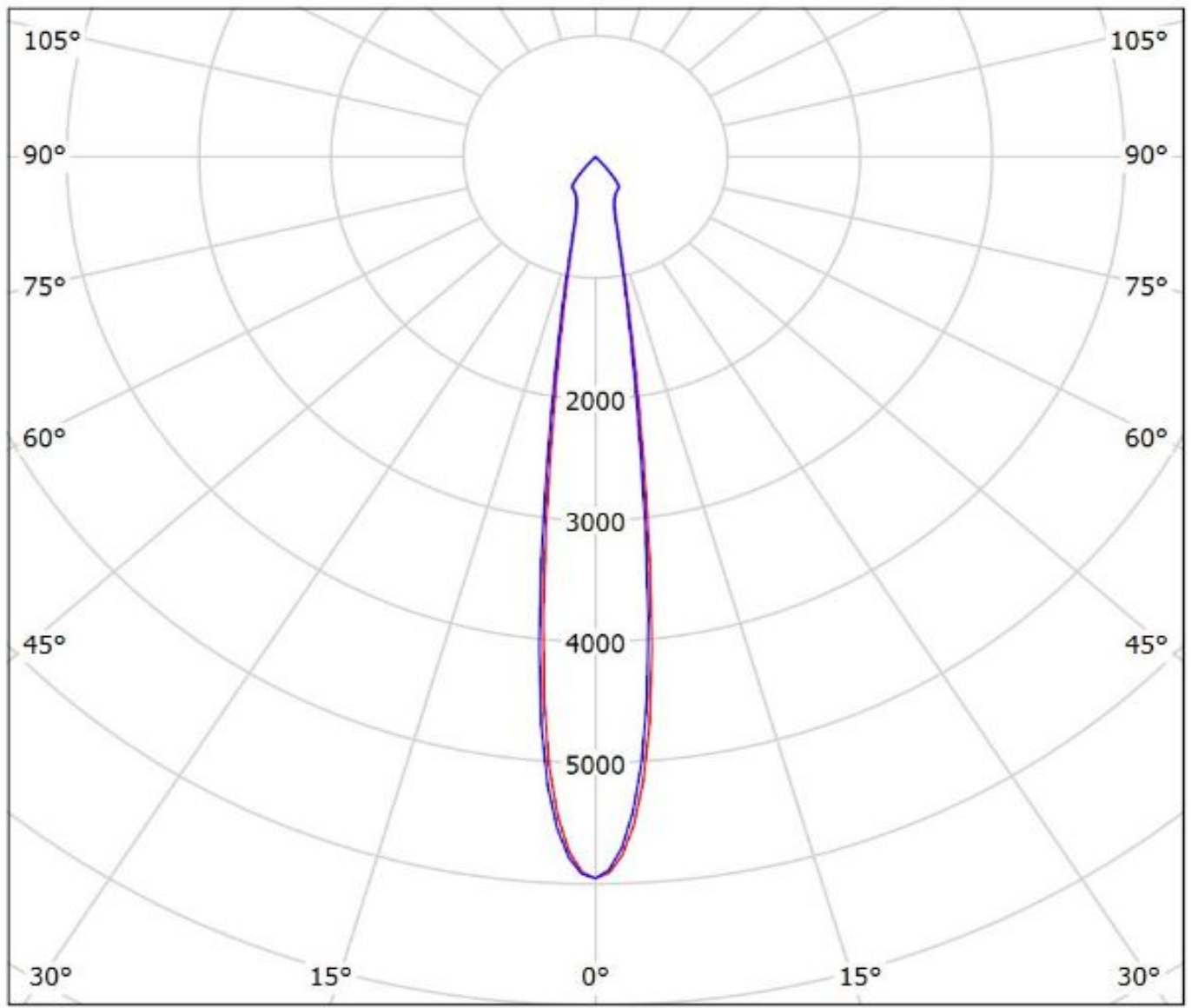

cd/klm
— C0 - C180 — C90 - C270

$\eta = 91\%$

Luminaire: Ledil F14616_ANGELETTE-S-B_(V22+STUCCHI)
Lamps: 1 x Bridgelux_V22_(BXRE30E6500H-Y2)
_+8102/G2_1226.78lm@250mA_CCT=3000K_P=8.111W_I=0.25A

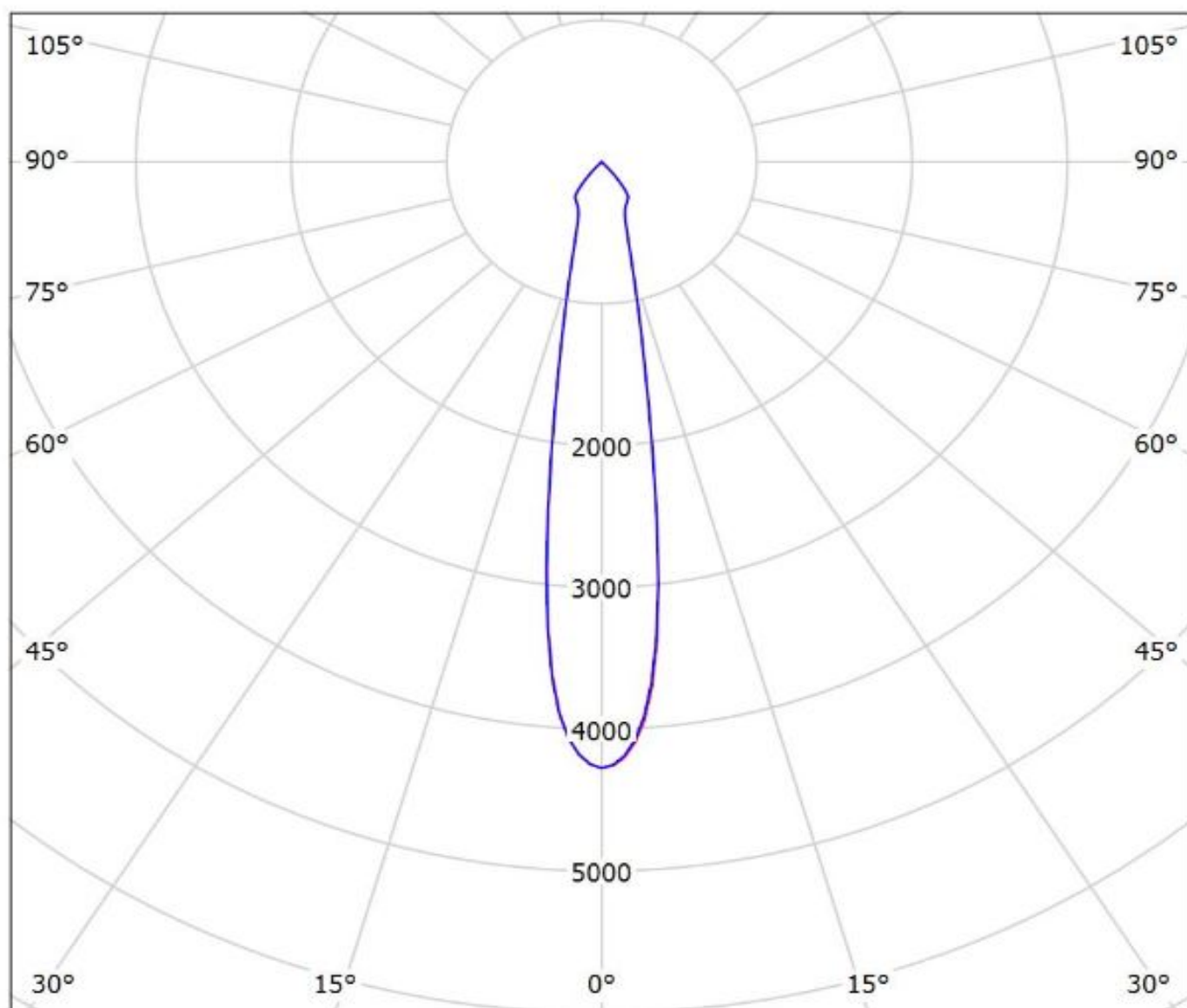

cd/klm

— C0 - C180 — C90 - C270

$\eta = 89\%$

Luminaire: LEDiL Oy F14616_ANGELETTE-S-B_(V18_Gen7)+BJB

Lamps: 1 x Bridgelux_V18_Gen7_(BXRE-30E4000-B)+BJB_47.319.2350_1384.73lm@250mA_P=8.09577W_I=0.25A

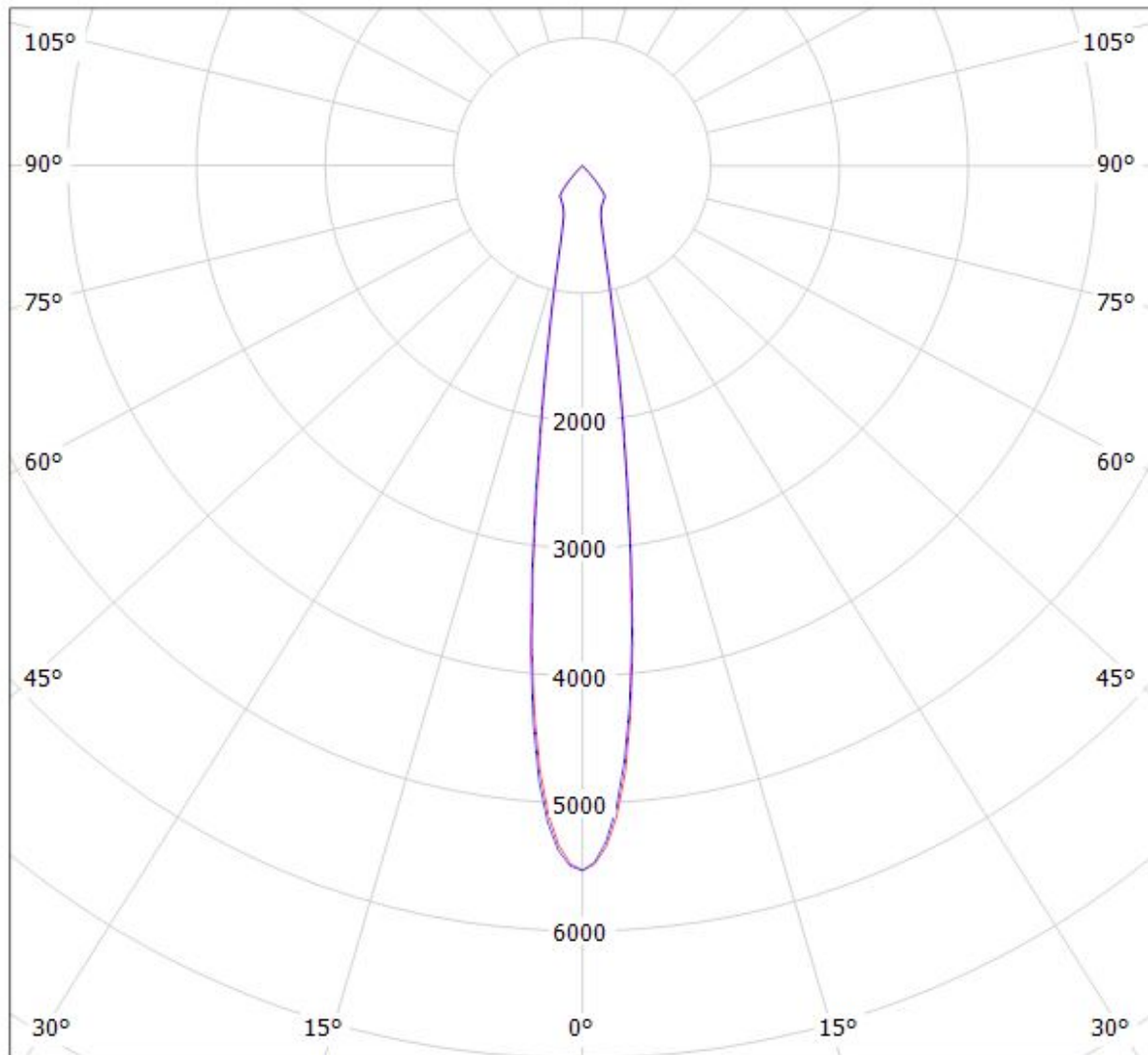

$\eta = 91\%$

cd/klm

— C0 - C180

— C90 - C270

Luminaire: Ledil Oy F14616_ANGELETTE-S-B_(CLU038)_(47_319_2021)_SIMULATED
Lamps: 1 x Citizen CLU038-1210C4-303M2K1 + BJB 47.319.2021 connector

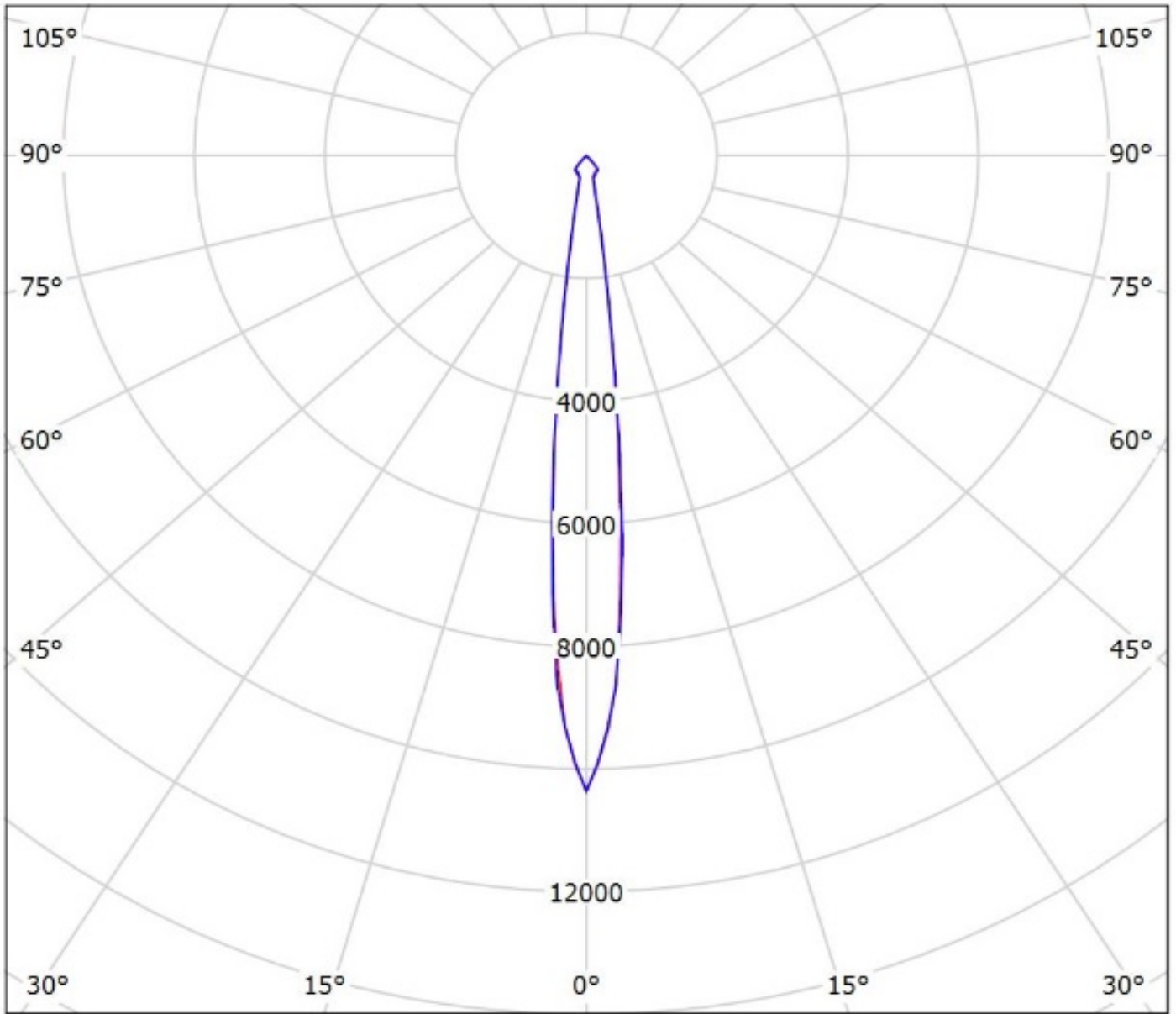

cd/klm
— C0 - C180 — C90 - C270

$\eta = 90\%$

Luminaire: Ledil Oy F14616_ANGELETTE-S-B_(CLU048)_ (47_319_2030)_SIMULATED
Lamps: 1 x Citizen CLU048-1818C4-303M2K1 + BJB 47.319.2030 connector

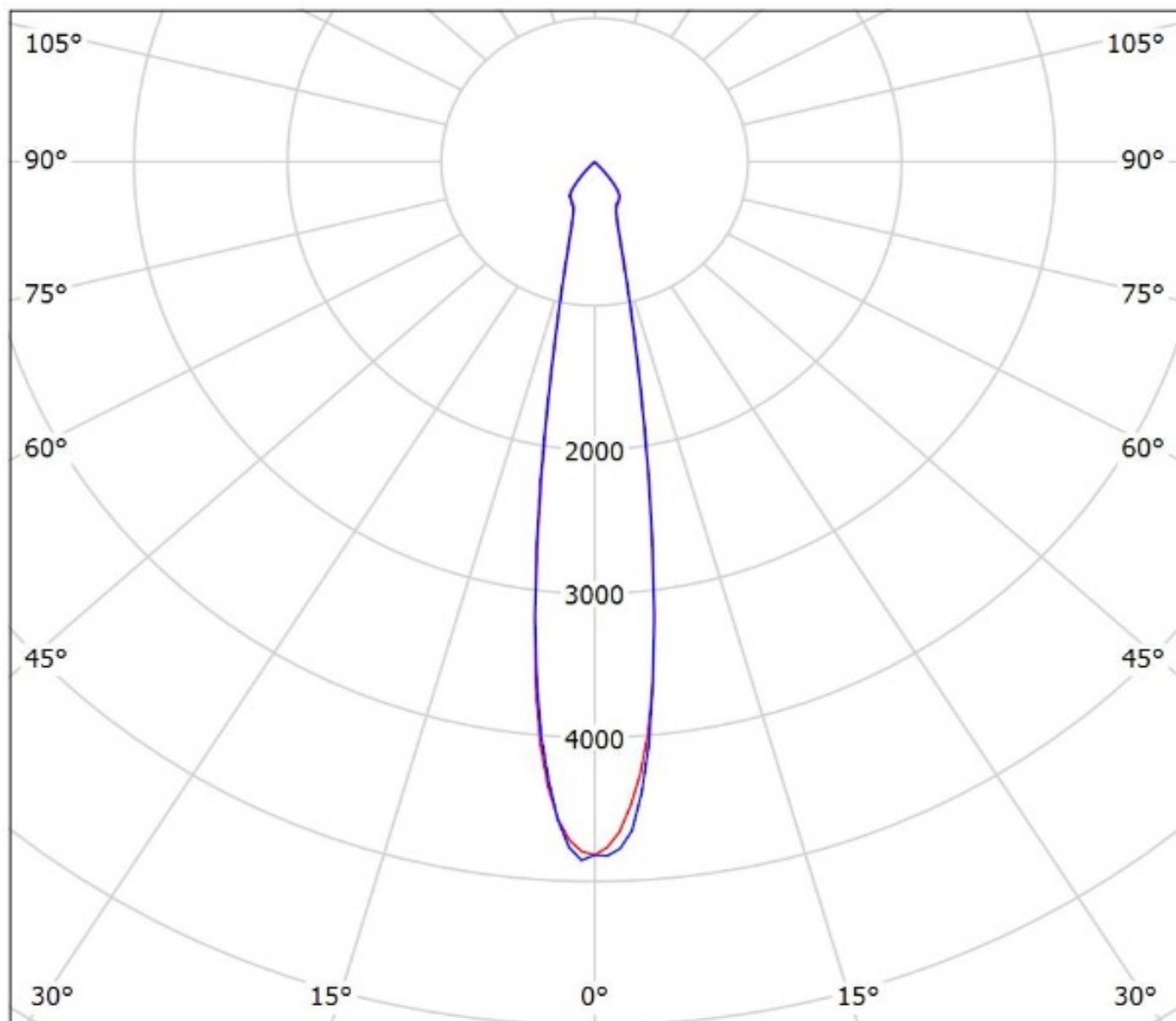

cd/klm
— C0 - C180 — C90 - C270

$\eta = 89\%$

Luminaire: LEDiL Oy F14616_ANGELETTE-S-B_(CXA1850)_STUCCHI_8403G2

Lamps: 1 x Cree_CXA1850_(CXA1850-30F-T4-N0Y-00001)+STUCCHI_8403G2_787.743lm@250mA_P=8.2479W_η=0.250

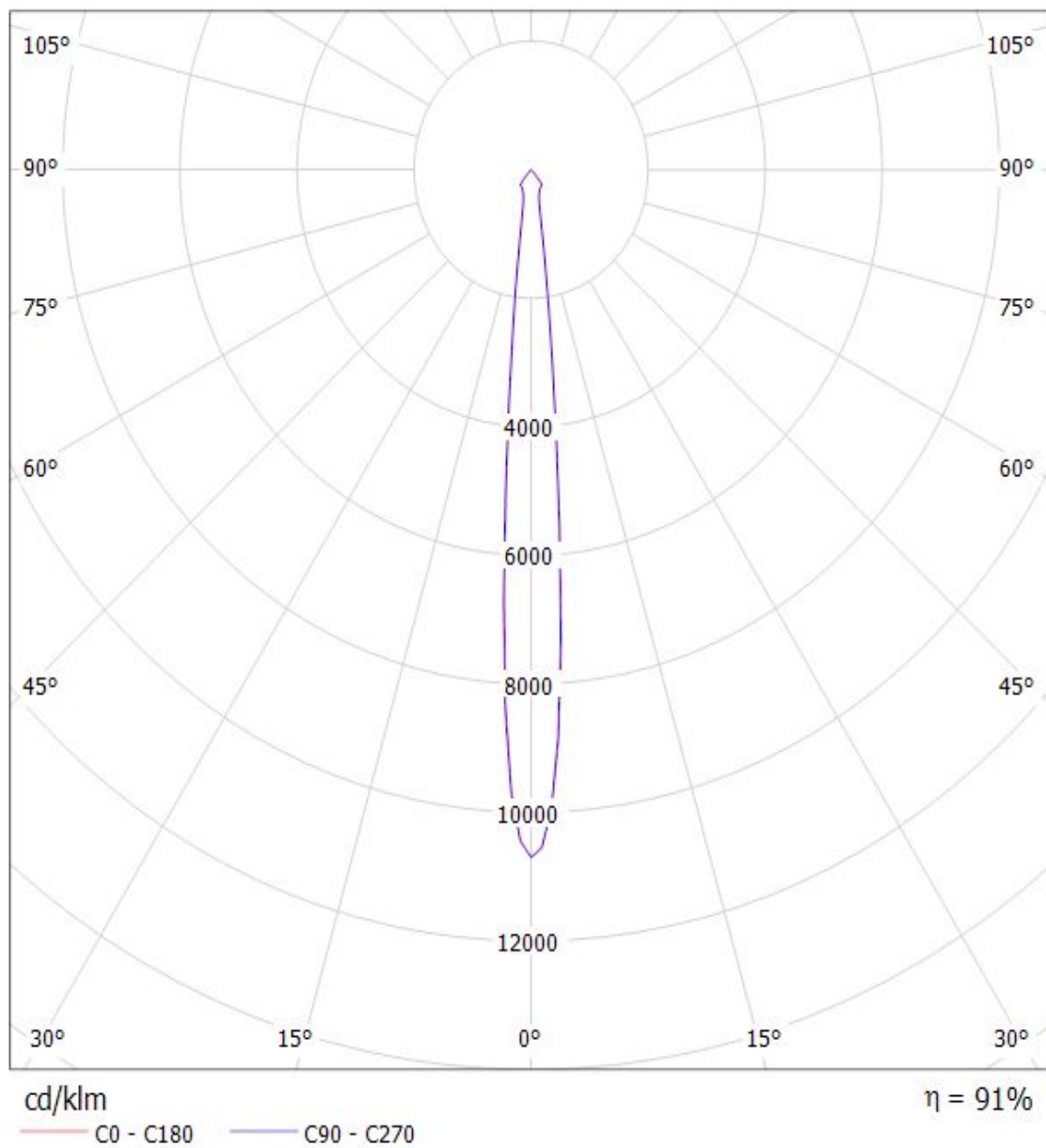

Luminaire: LEDiL Oy F14616_ANGELETTE-S-B_(CXA2520)+STUCCHI_8401/G2
Lamps: 1 x Cree_CXA2520_(2520-7A-N4-N0U)_888.176lm@250mA_P=8.65835W_I=0.250A

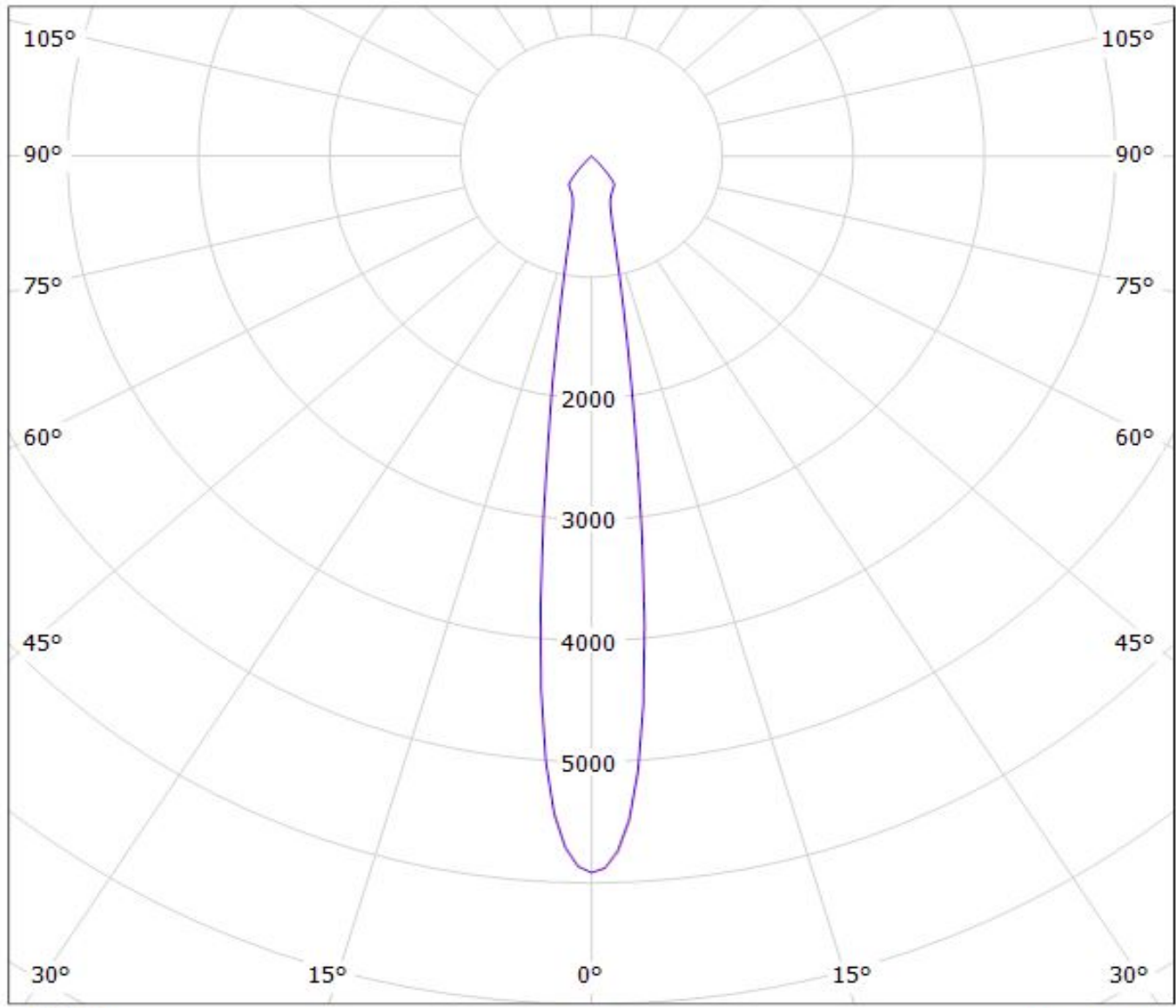

cd/klm
— C0 - C180 — C90 - C270

$\eta = 90\%$

Luminaire: Ledil F14616_ANGELETTE-S-B_(CoB1208+STUCCHI)

Lamps: 1 x Luxeon_CoB1208_(L2C2-4080)_+_8301/G2_1410.19lm@250mA_P=8.1722W_I=0.25A

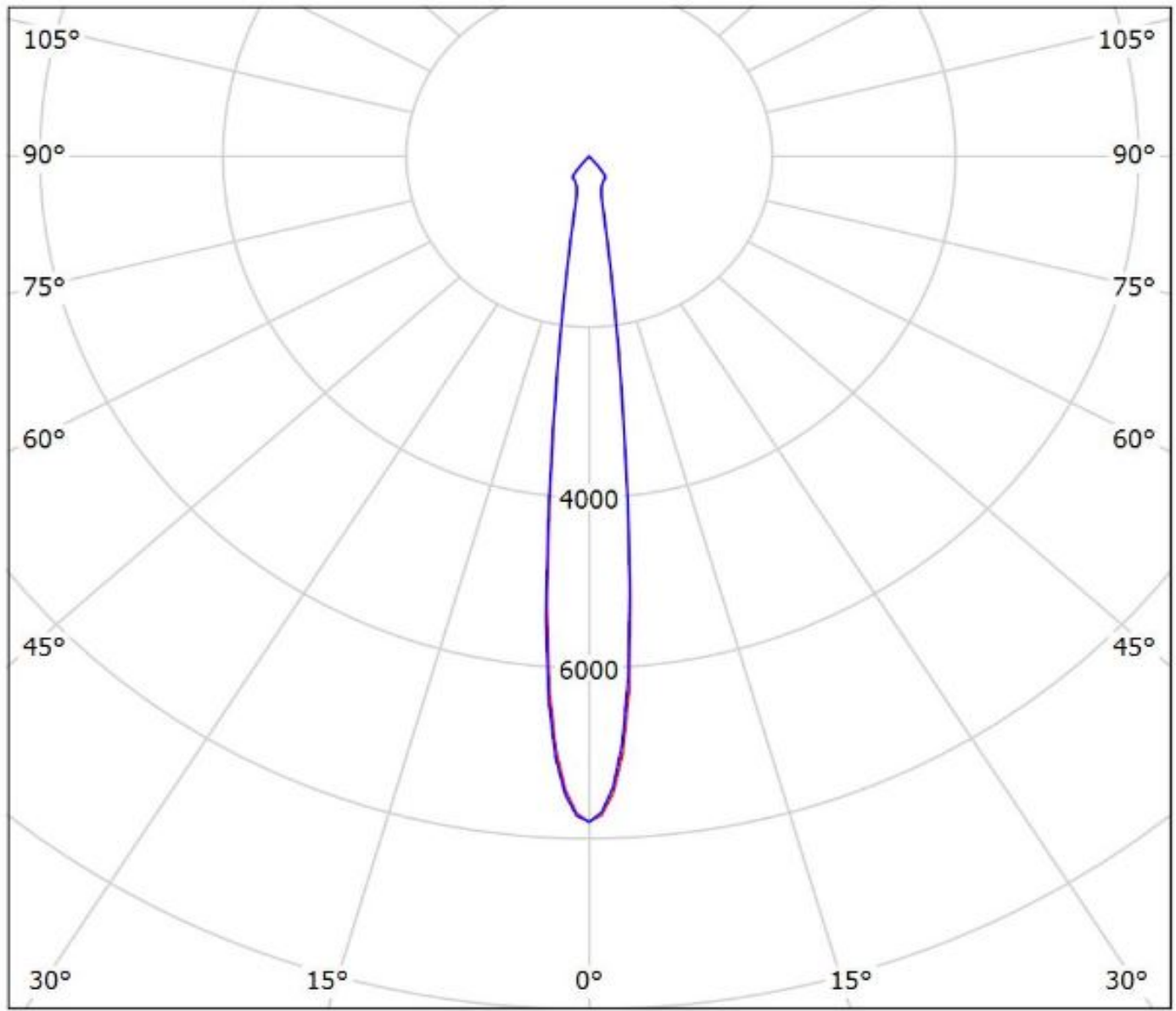

cd/klm

— C0 - C180 — C90 - C270

$\eta = 91\%$

Luminaire: Ledil Oy F14616_ANGELETTE-S-B+_BJB_47.319.2030_SAMSUNG_COB_D_LC040D_SIMULATED
Lamps: 1 x SAMSUNG LC040D

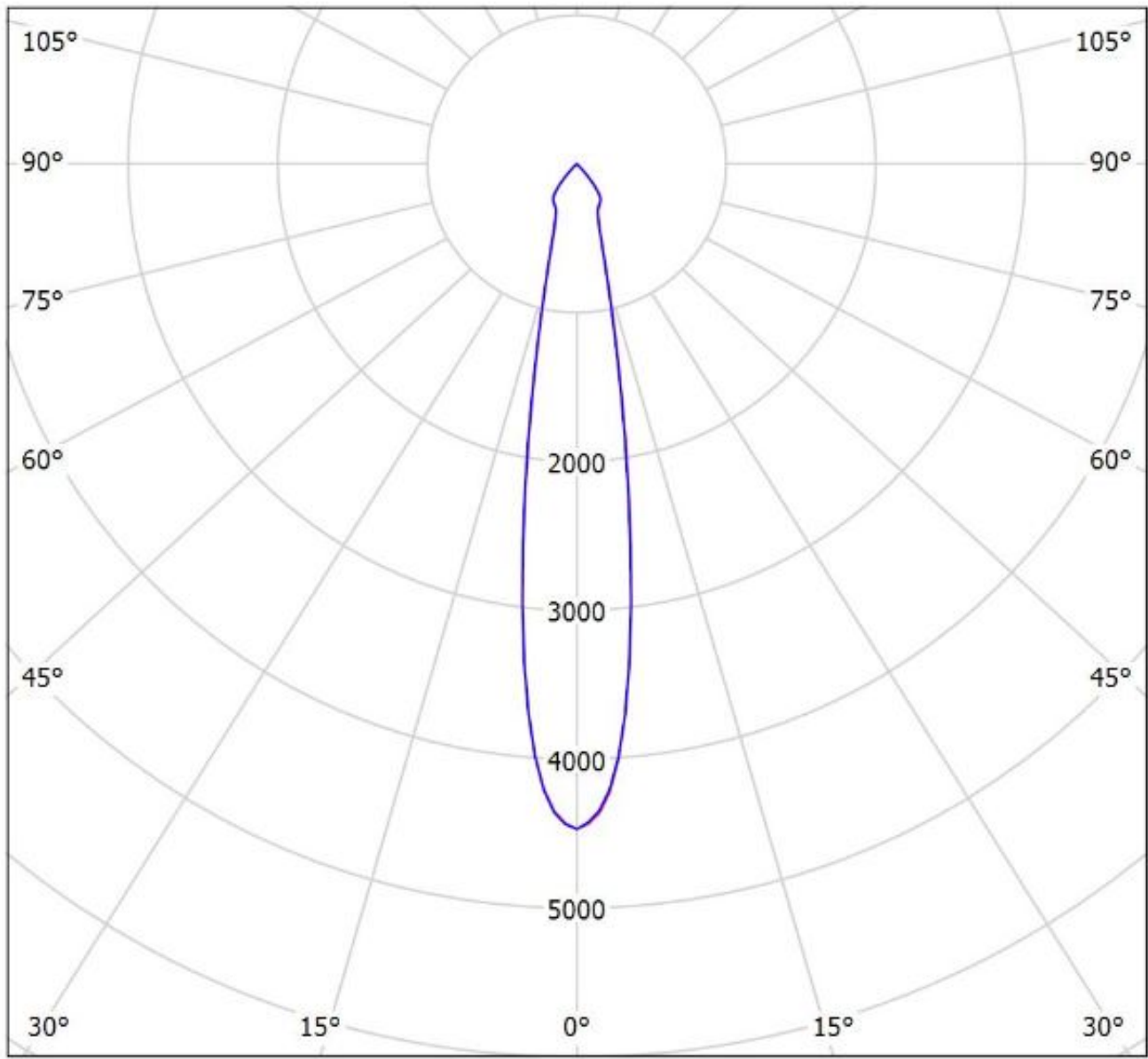

cd/klm

— C0 - C180 — C90 - C270

$\eta = 88\%$

Luminaire: LEDiL Oy F14616_ANGELETTE-S-B_(COB_D_14,5mm)

Lamps: 1 x Samsung_COB_D_Series-LES-14,5_LC026D_1296.34lm@250mA_CCT=3000K_P=8.1225W_I=0.250A

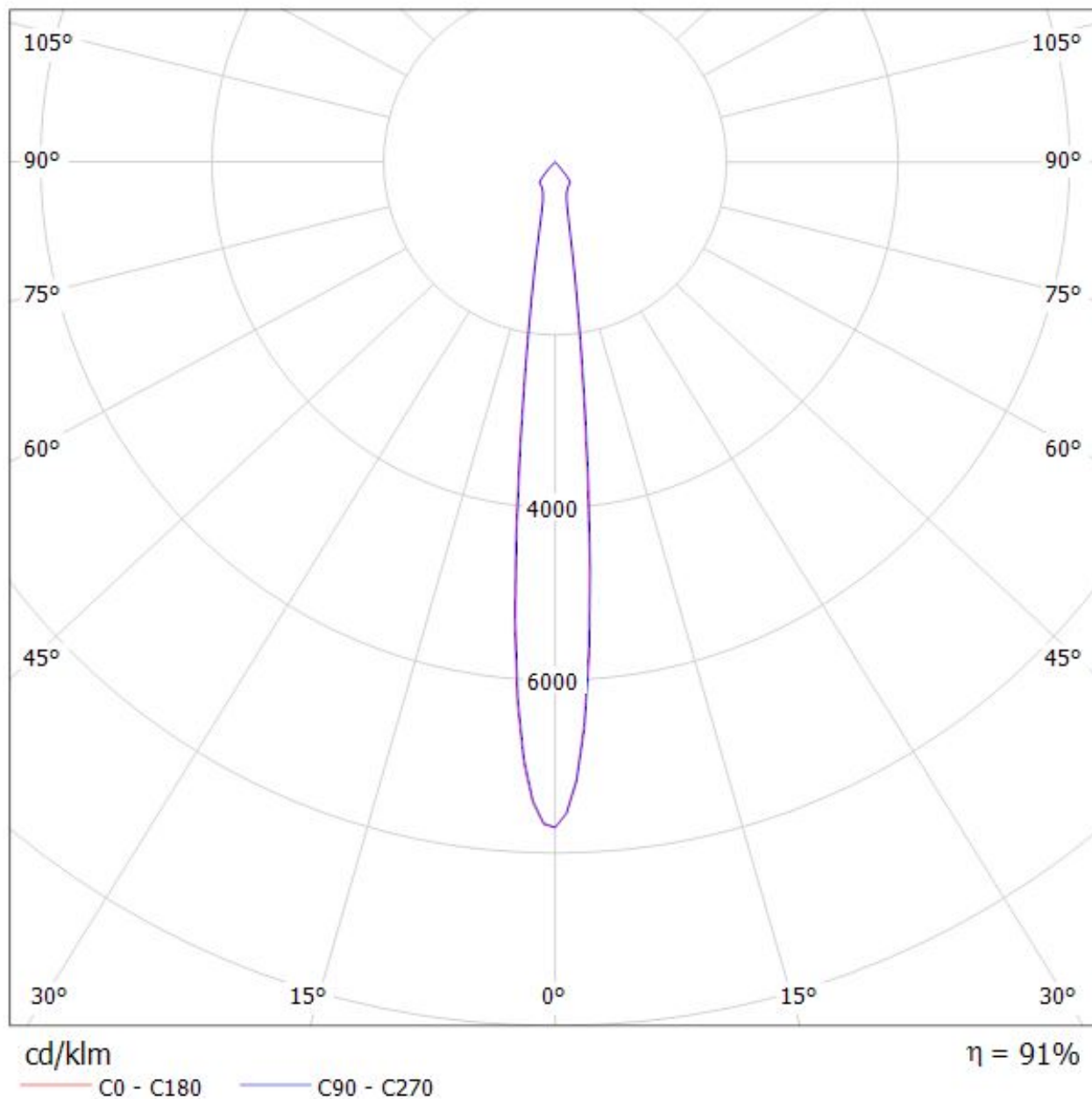

Luminaire: LEDiL Oy F14616_ANGELETTE-S-B_(COB_D_14,5mm)

Lamps: 1 x Samsung_COB_D_Series-LES-14,5_LC026D_1296.34lm@250mA_CCT=3000K_P=8.1225W_I=0.250A

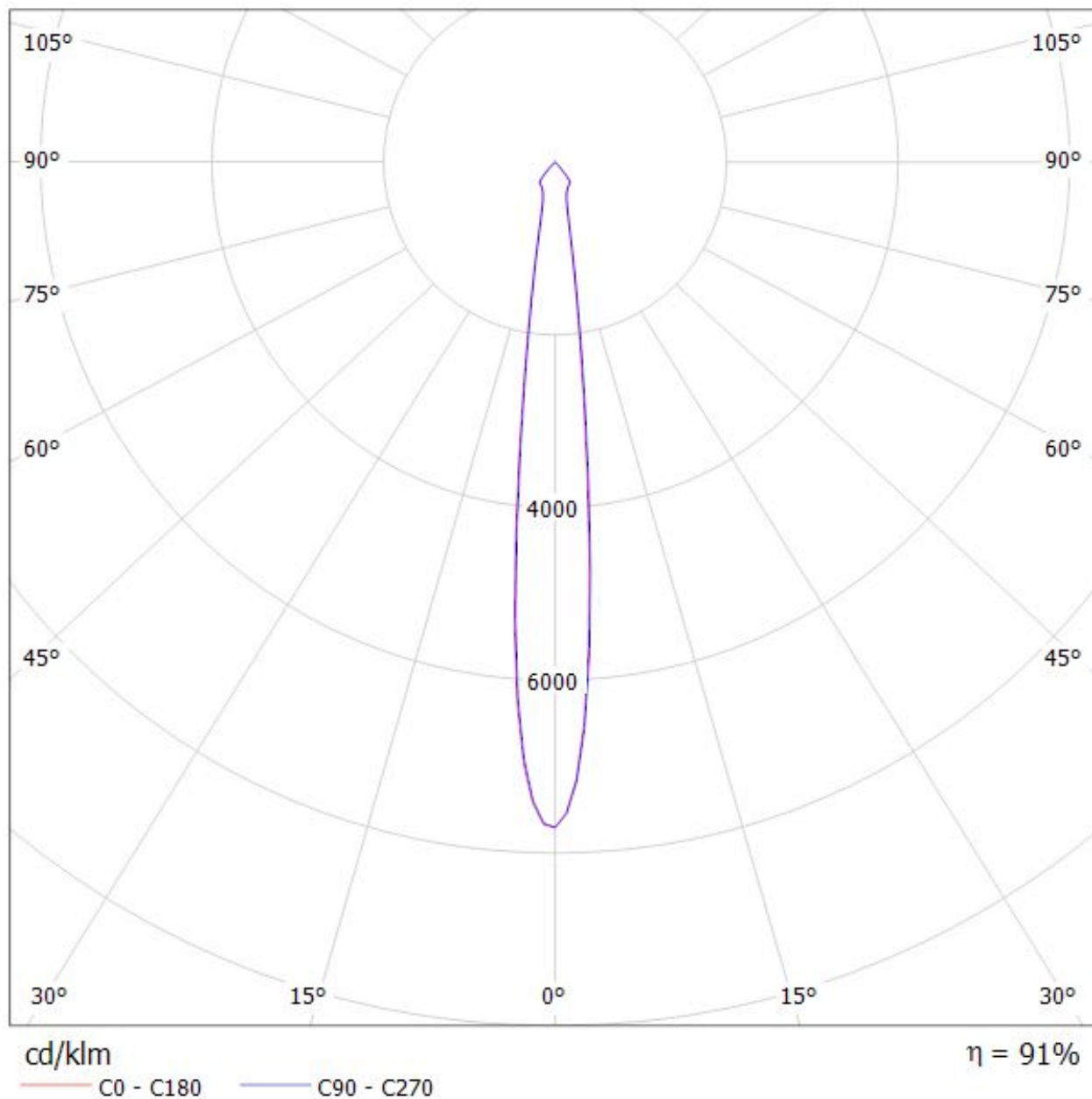

Luminaire: Ledil Oy F14616_ANGELETTE-S-B_TRIDONIC_SLE_G6_LES19_H_SIMULATED
Lamps: 1 x TRIDONIC SLE G6 LES19 H

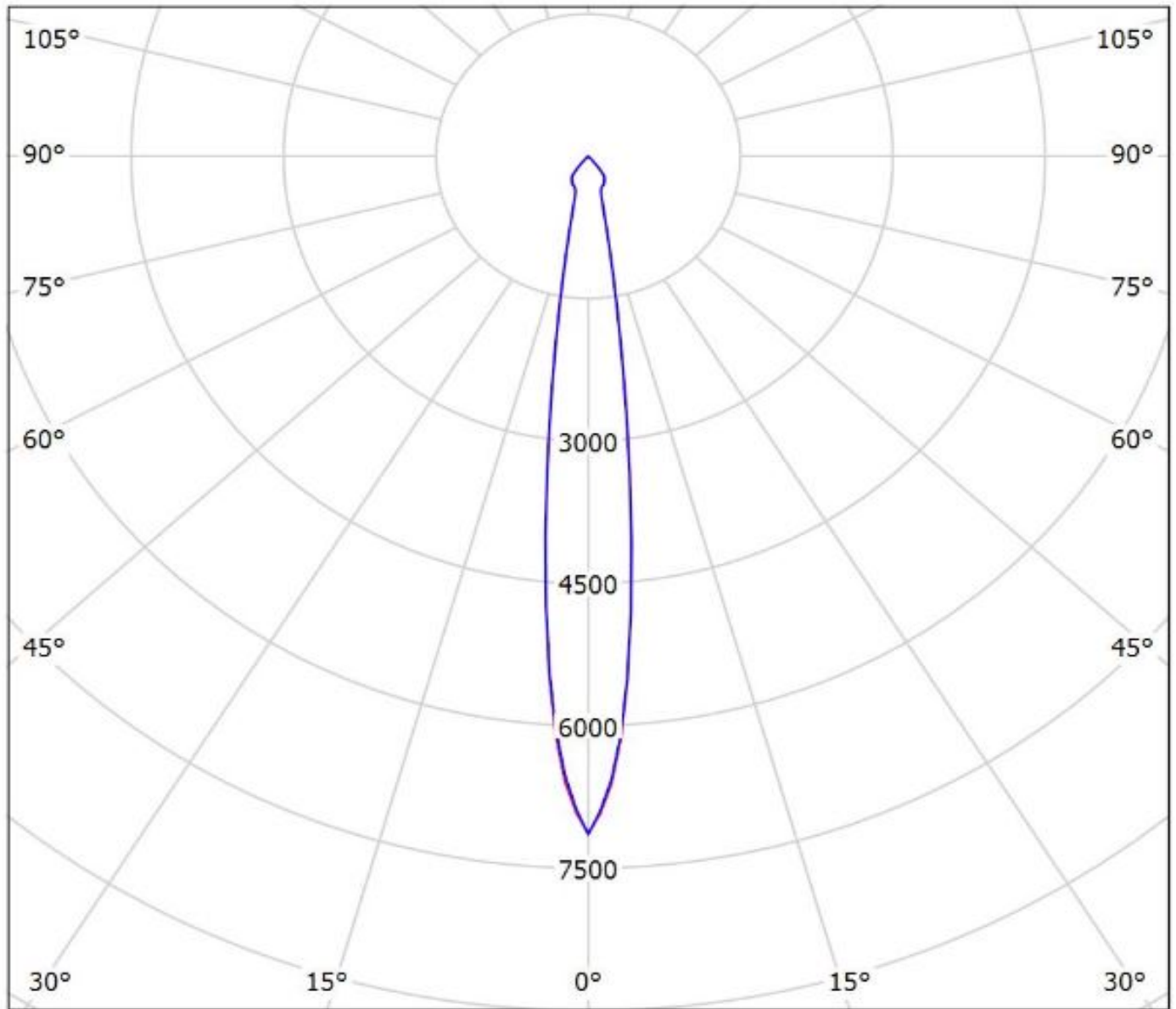

cd/klm
— C0 - C180 — C90 - C270

$\eta = 89\%$

Luminaire: Ledil Oy F14616_ANGELETTE-S-B_TRIDONIC_SLE_G6_LES23_H_SIMULATED
Lamps: 1 x TRIDONIC SLE G6 LES23 H

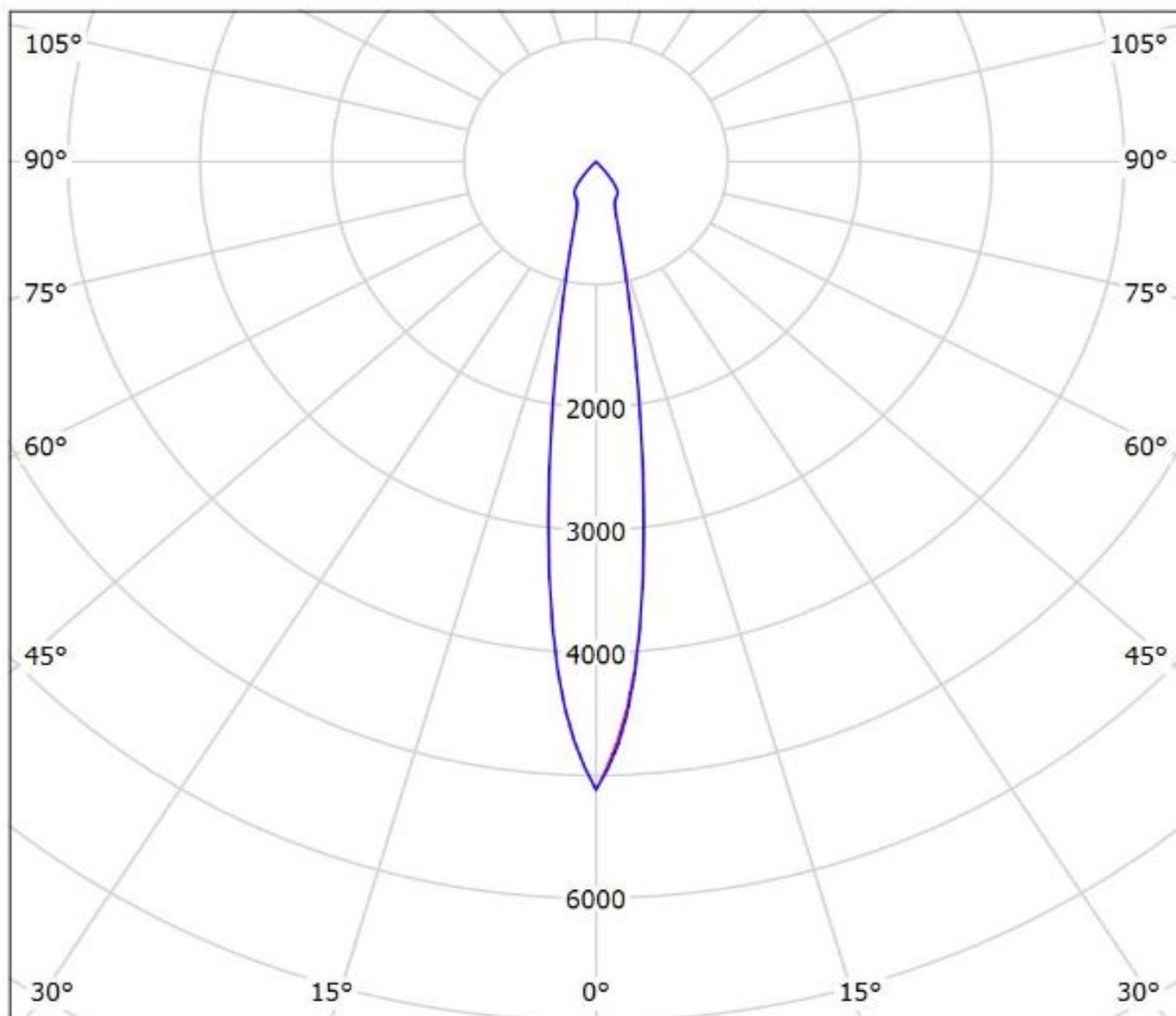

cd/klm

— C0 - C180 — C90 - C270

$\eta = 89\%$

Luminaire: Ledil Oy F14616_ANGELETTE-S-B_(SLE_G6_LES17_H)_SIMULATED
Lamps: 1 x Tridonic SLE G6 LES17 H

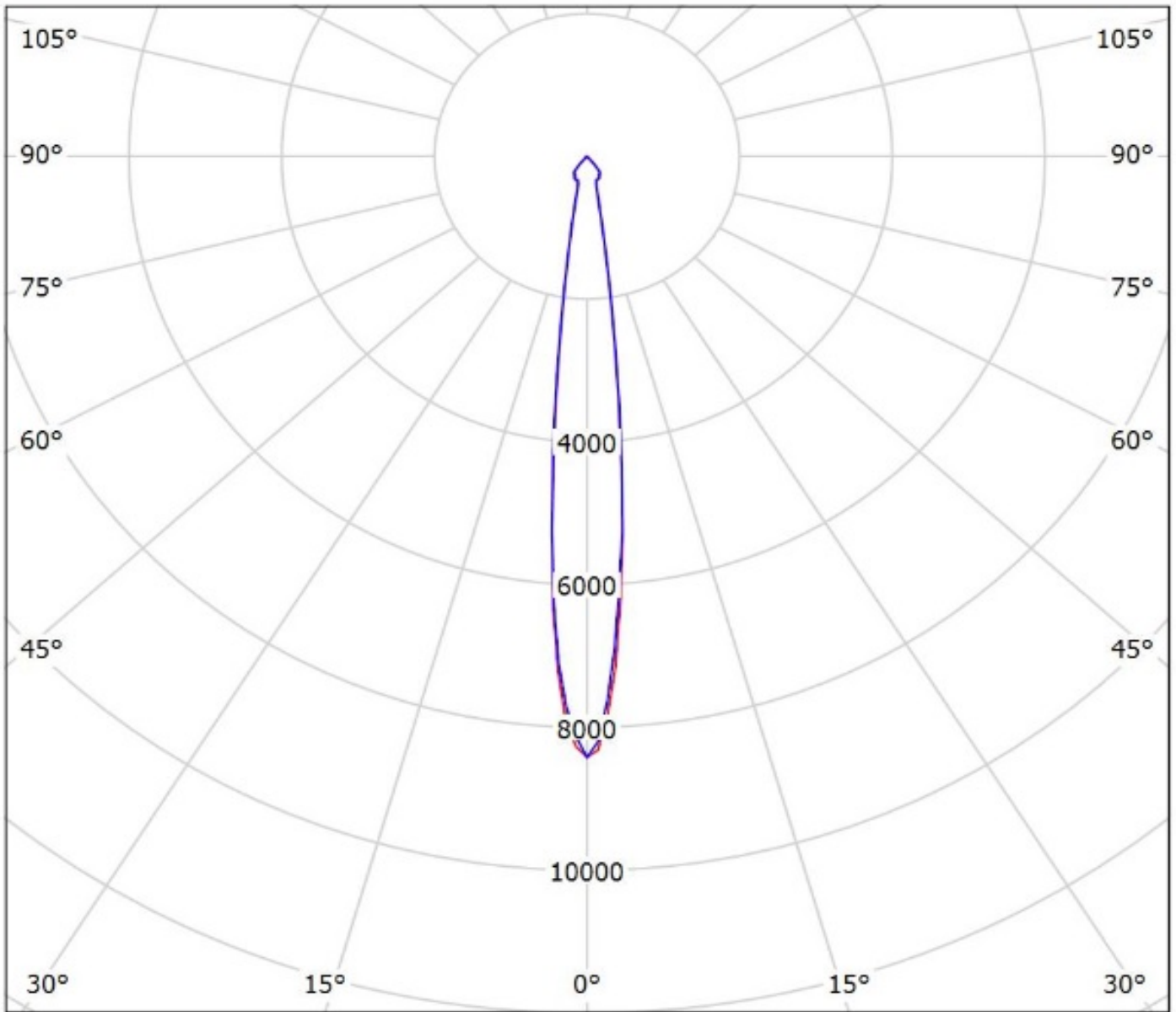

cd/klm

— C0 - C180 — C90 - C270

$\eta = 89\%$

NOTE: The typical divergence will be changed by different color, chip size and chip position tolerance. The typical total divergence is the full angle measured where the luminous intensity is half of the peak value.

GENERAL INFORMATION

- Product series especially designed & optimized for series of LEDs.
- Special care taken to make light distribution as uniform as possible.

Note! Due to use of high power COB's with this product, special attention to proper thermal design is highly recommended. LEDiL has no liability for direct, indirect or consecutive damages arising from the LEDiL products being used outside of the recommended temperature range.